

SL POWER TF3000HV SERIES

3000 Watts Single Output
Industrial Grade



Advanced Energy's SL Power TF3000HV series of industrial grade AC-DC fan-cooled power supply comprises seven output models. All models feature industrial safety approvals and accept a universal input of 90 to 264 VAC. These compact switch-mode power supplies feature output overvoltage, overtemperature, overload protection, with short-circuit protection on all output models. TF3000HV series power supplies provide up to 3000 Watts of output power with remote setting multiple PSU and global control function.

SPECIAL FEATURES

- 3000 W Fan-Cooled (Load & Temperature Controlled)
- Programmable Output Voltage (0% to 105%)
- Programmable Output Current (0% to 105%)
- Forced Current Sharing at Parallel Operation
- Constant Current Limit
- Selectable +5 V/0.5 A or +9 V/0.3 A Auxiliary Output
- Remote Setting Multiple PSU via I²C & RS232 & RS485
- Power OK Signal
- Remote ON/OFF, Remote Sense Function
- Protection: OVP, OLP, OTP, Fan Failure
- 3 Year Warranty

- RoHS Compliant
- Conformal Coating Applied

SAFETY

- EN/UL62368-1

AT A GLANCE

Total Power

Up to 3000 Watts

Input Voltage

90 to 264 VAC

of Outputs

Single



ELECTRICAL SPECIFICATIONS

Input	
Input Voltage and Frequency ¹	90 to 264 VAC, 47 to 63 Hz, 1Ø 127 to 370 VDC
Input Current	19.7 A @ 115 VAC (2000 W output), 14.5 A @ 230 VAC (3000 W output)
Inrush Current	33 A/115 VAC, 65 A/230 VAC
Efficiency	See Model Selection Table
Power Factor	0.95/230 VAC, 0.98/115 VAC at full load
Leakage Current	<3.5 mA/240 VAC
Output	
Output Voltage	See Model Selection Table
Output Power ¹	3000 W continuous - see models chart for specific voltage model ratings
Voltage Range	±5.0% typical adjustment by potentiometer (VR1)
Voltage Tolerance	See Model Selection Table
Hold-Up Time	14 mS/230 VAC at full load
Turn On Time	1100 mS
Rise Time	300 mS at full load
Ripple and Noise	See Model Selection Table
Line/Load Regulation	See Model Selection Table
Auxiliary Signals	
Auxiliary Power	Selectable +5 V/0.5 A or +9 V/0.3 A auxiliary output
Remote On / Off Control	By external switch
Power OK Signa	Open drain signal low when PSU turns on. Max sink current: 20 mA. Max drain voltage: 40 V
Output Voltage Trim	Adjustment of output voltage is between 0 to 105% of rated output
Output Current Trim	Adjustment of output voltage is between 0 to 105% of rated output
Parallel (Current Sharing) ²	Please refer to current sharing with remote sensing (parallel connection) diagram
Reliability	
MTBF	>112,000 hours per MIL-HDBK-217F
Protection	
Overvoltage Protection	Variable OVP refer to VCI vs OVP curve.(OVP tolerance 7%), latch type (recovery after reset AC power ON or inhibit).
Short Circuit Protection	Constant current, auto-recovery
Overload Protection	105% of rated power, constant current type
Overtemperature Protection	85±5°C measured on NTC, auto-recovery
Safety	
Safety Certifications	EN62368-1, UL62368-1
Isolation Specifications	
Isolation ³	Input-Output: 3000 VAC Input-Ground: 1500 VAC Output-Ground: 500 VAC
Isolation Resistance	I/P-O/P, I/P-FG, O/P-FG: 100 Mohms/500 VDC

Notes:

1. Derating may apply in low input voltage. Please check the derating curve for details.
2. In parallel connection only one unit will operate if the total output load is less than 5% of the rated power.
3. This test is done without enclosure: I/P-O/P 4242 VDC. If with enclosure: I/P-O/P 2121 VDC, I/P-FG:2121 VDC, O/P-FG: 707 VDC

EMI/EMC COMPLIANCE

Conducted Emissions	Certified EN55022; EN61204-3; EN61000-6-3
Radiated Emissions	Certified EN55022; EN61204-3; EN61000-6-3
Electro-Static Discharge (ESD) Immunity On Power Ports	EN55024/IEC61000-4-2
Radiated RF EM Fields Susceptibility	EN55022/EN61000-4-3
Electrical Fast Transients (EFT)/Burst	EN55024/IEC61000-4-4
Surges, Line to Line (Diff Mode) and Line to Gnd (CMN Mode)	EN55024/IEC61000-4-5
Conducted Disturbances Induced by RF Fields	EN55022/IEC61000-4-6
Rated Power Frequency Magnetic Fields	EN55024/IEC1000-4-8
Voltage Interruptions, Dips, Sags & Surges	EN55024/IEC/EN61000-4-11
Harmonic Current Emissions	EN61000-3-2
Flicker Test	EN61000-3-3

Note:

The power supply is considered a component which will be installed into a final equipment. The final equipment must be re-confirmed that it still meets EMC directives.

ENVIRONMENTAL SPECIFICATIONS

Operating Temperature	-25°C to +60°C (Refer to load de-rating curve)
Temperature Derating	See derating curve
Vibration	10 to 500 Hz, 2 G 10 min./1 cycle, period for 60 min. each along X, Y, Z axes Compliance to IEC68-2-6, IEC68-2-64
Dimensions	170 x 64 x 280 mm (6.69 x 2.5 x 11.02 in)
Cooling	Load and temperature control fan
Relative Humidity	20% to 90%, non-condensing
Storage Temperature and Humidity	-40 to +85°C, 10 to 95% RH
Weight & Packing	2.6 kg 6 pcs/carton, 16.6 kg/1.86 CUFT

CONNECTOR INFORMATION

	Input Connector	Output Connector	Signal Connector
Pinout	Term. 1) AC LINE Term. 2) NEUTRAL Term. 3) GROUND	+ and -	See Signal Connector table on pg 4
Mating Connector/Terminal	#10 wire lugs	1/4-20 wire lugs	Connector: JST PHDR-24VS or equivalent Pins: JST SPHD-002T-P0.5 or equivalent

MECHANICAL DRAWING

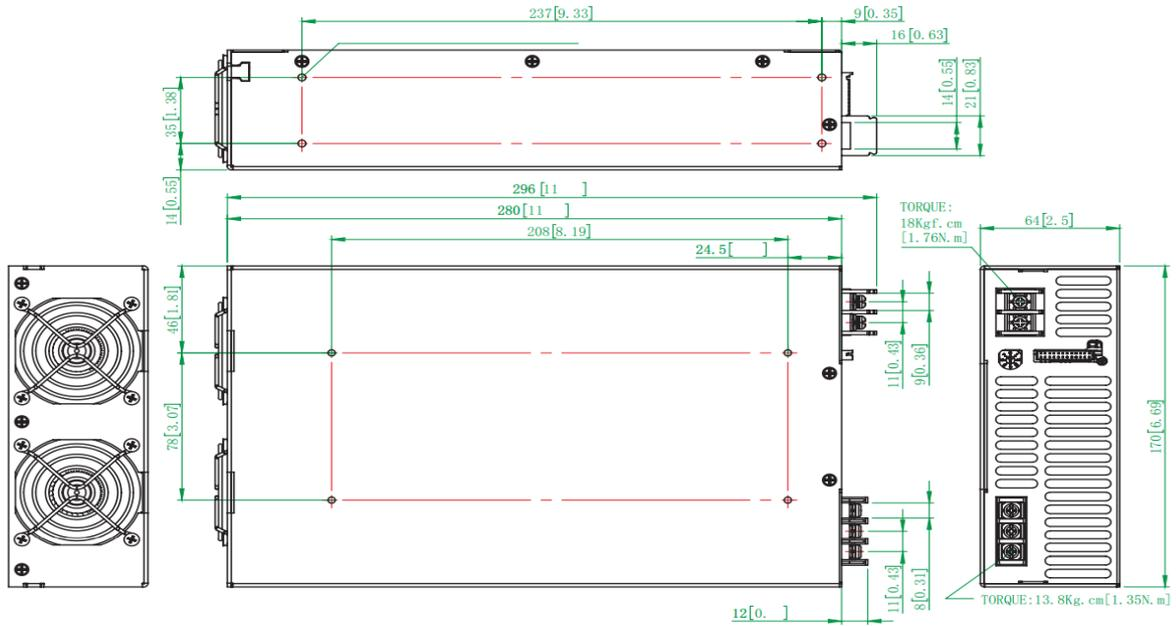

Unit: mm / inch

Recommended screw length is measured from the power supply surface.

Pin No.	Assignment
L	VS+
N	VO+
⏏	⏏

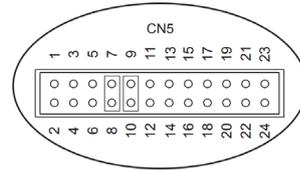

Control pin number assignment (CN2): JST S24B-PHDSS or equivalent						
Pin No.	Assignment	Pin No.	Assignment	Pin No.	Assignment	Mating Housing / Contact
1	NC.	9	EN-	17	AUX	JST PHDR-24VS or equivalent JST SPHD-002T-P0.5 or equivalent
2	NC.	10	GND	18	GND.	
3	NC.	11	EN+	19	SCL	
4	NC.	12	AUX	20	SDA	
5	POK	13	ACI	21	AUX	
6	GND	14	GND	22	GND	
7	PAR	15	VCI	23	DA-	
8	VSET	16	GND	24	DA+	

MECHANICAL DRAWING (CONTINUED)

CN2 Function					
Pin No.	Function	Description	Pin No.	Function	Description
1	NC.		13	ACI	I program
2	NC.		14	GND	Ground
3	NC.		15	VCI	V program
4	NC.		16	GND	Ground
5	POK	Power OK	17	AUX	+5 V / 0.5 A or +9 V / 0.3 A auxiliary power
6	GND	Ground	18	GND	Ground
7	PAR	Parallel operation current share	19	SCL	Serial clock for I ² C interface
8	VSET	Aux output setting	20	SDA	Serial data for I ² C interface
9	EN-	Inhibit ON/OFF (-)	21	AUX	+5 V / 0.5 A or +9 V / 0.3 A auxiliary power
10	GND	Ground	22	GND	Ground
11	EN+	Inhibit ON/OFF (+)	23	DA-	For RS485 Data- Interface
12	AUX	+5 V / 0.5 A or +9 V / 0.3 A auxiliary power	24	DA+	For RS485 Data+ Interface

LED STATUS INDICATOR

LED	LED Signal	Status
Solid (Green)		Power OK (Local Mode)
Solid (Orange)		Power OK (Remote Mode)
Slow Blink (Green)		Power Standby (Local mode)
Slow Blink (Orange)		Power Standby (Remote mode)
Fast Blink (Red)		Over Voltage Protection (OVP)
Solid (Red)		Over Load Protection (OLP)
Slow Blink (Red)		Over Temperature Protection (OTP)
Intermittent Blink (Red)		Fan Failure
Interlace Blink (Red)		Power Failure

*Local mode : Use ACI/VCI to control output current and voltage.
 Remote mode : Use RS-232/485 or I²C command to control output current and voltage.

REMOTE ON/OFF

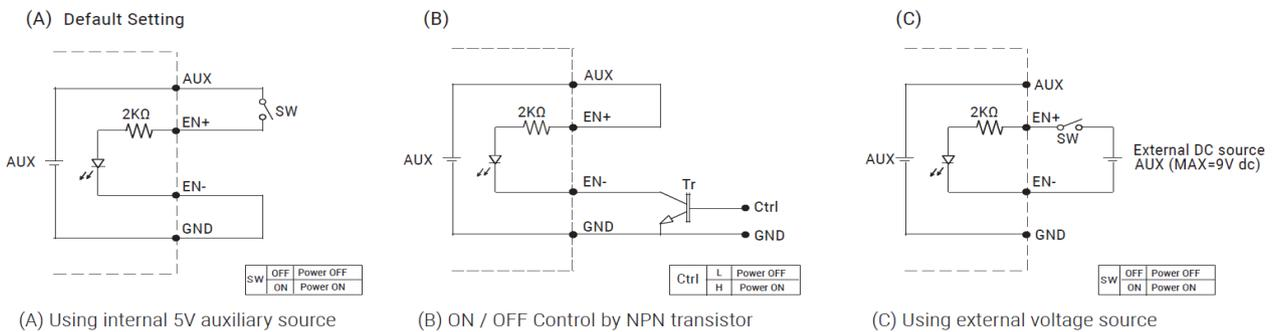

Note:
 GND shown in above diagram is referring to the GND of CN2, not the Grounding from main power (NEG-).

MODEL SELECTION

Model Number ¹	Output Volts	Rated Current	Current Range	Output Power	Ripple & Noise ²	Line Regulation	Load Regulation	Voltage Tolerance ³	Efficiency
TF3000A150K	150 V	20 A	0 - 20 A	3000 W	1500 mV pk-pk	± 1%	± 1%	± 2%	93%
TF3000A200K	200 V	15 A	0 - 15 A	3000 W	2000 mV pk-pk	± 1%	± 1%	± 2%	93%
TF3000A250K	250 V	12 A	0 - 12 A	3000 W	2500 mV pk-pk	± 1%	± 1%	± 2%	93%
TF3000A300K	300 V	10 A	0 - 10 A	3000 W	3000 mV pk-pk	± 1%	± 1%	± 2%	93%
TF3000A400K	400 V	7.5 A	0 - 7.5 A	3000 W	4000 mV pk-pk	± 1%	± 1%	± 2%	93%

Notes:

1. Other output voltages available, consult factory.
2. Ripple & noise are measured at 20 MHz of bandwidth by using a 12" twisted pair-wire terminated with a 0.1 uF & 47 uF parallel capacitor.
3. Tolerance: includes setup time tolerance, line regulation and load regulation.
4. All specifications are typical at 230 VAC, full load, at 25°C ambient unless noted.
5. De-rating may apply in low input voltage. Check the derating curve for details

DERATING CURVE

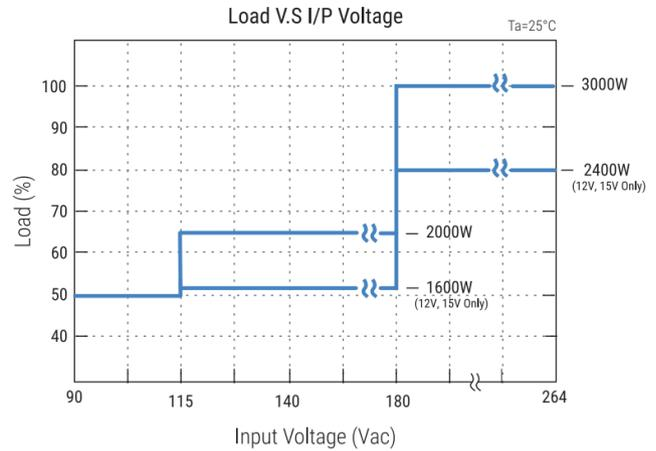
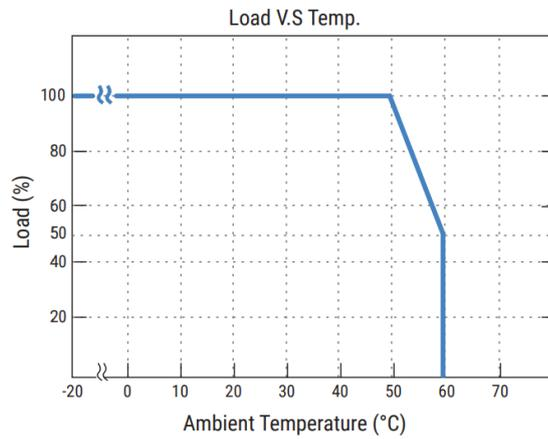

DERATING CURVE (CONTINUED)

CMD vs Output Curve

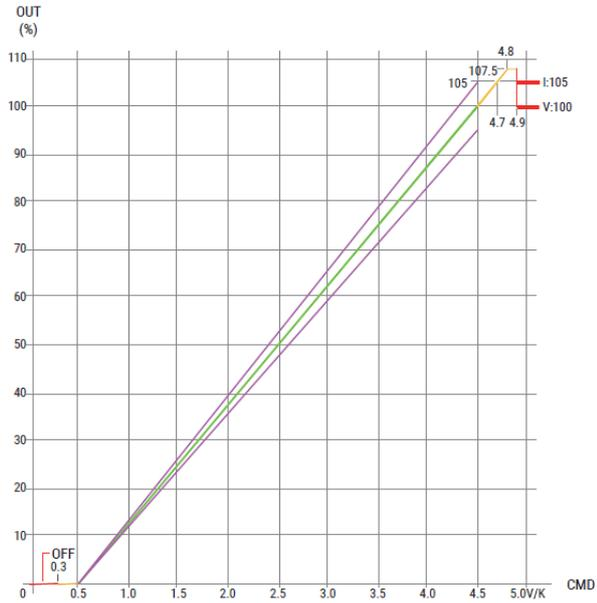

VCI vs OVP Curve

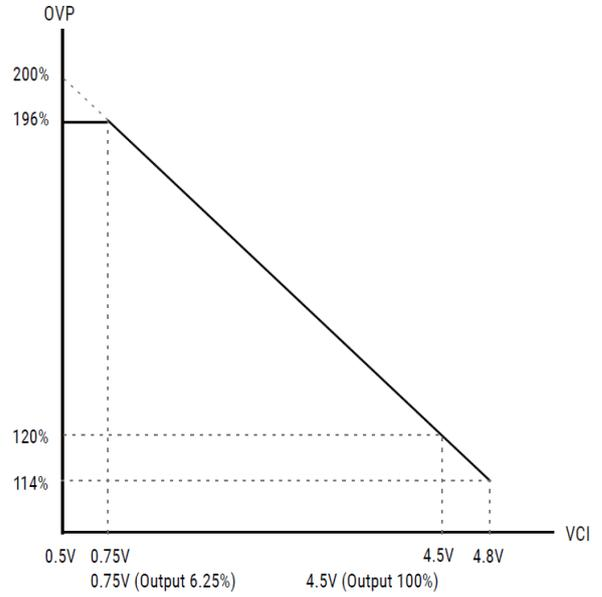

To ensure the power supply output voltage and current could be accurately adjusted, please make sure to adjust the output voltage and current > 10% vs. the rated voltage and current. (e.g. for a 24 V unit, please adjust the DC output voltage above 2.4 V to ensure accuracy; same applies to the output current)

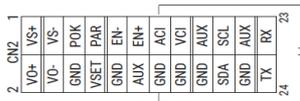

External Voltage (VDC)

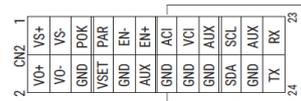

External Resistor (KΩ)

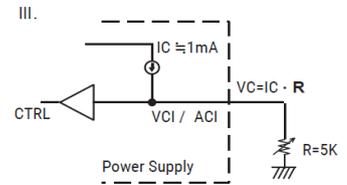
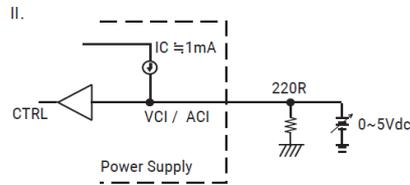
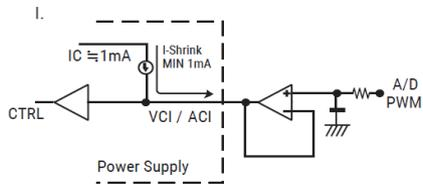

DERATING CURVE (CONTINUED)

Power OK Signal & Auxiliary Power Setting

The grounding of "AUX" power and P. OK signal should be connected to "GND" port. If "VO-" is connected as Grounding, make sure to short the GND and VO- ports.

Open drain signal low when PSU turns on. Max. P. OK sink current: 20 mA, Max, drain voltage: 40 V.

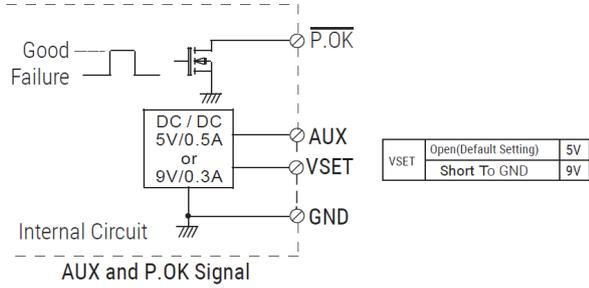

Note:
GND shown in above diagram is referring to the GND of CN2, not the Grounding from main power (NEG-).

Place an additional capacitor to have a better performance of auxiliary power operation.

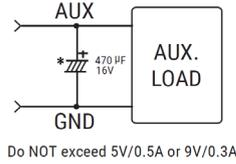

RS485 Communication Connection Diagram

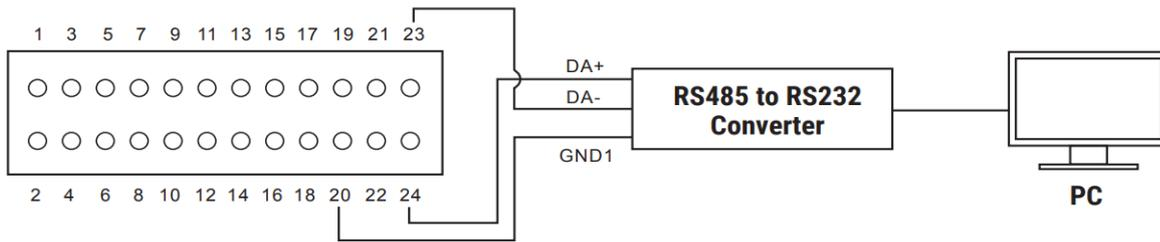

Note:
Make sure GND1 (pin 20) is connected to the external communication kit when using RS485 / I²C.

CURRENT SHARING

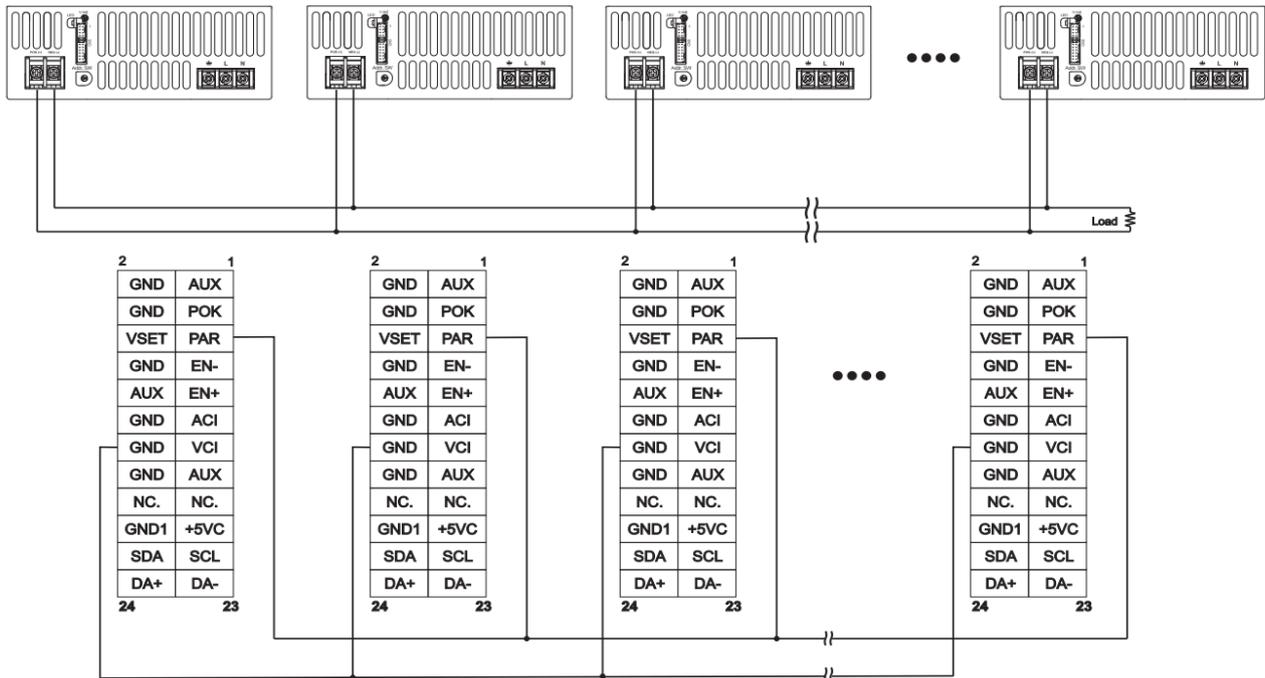

Remarks:

- AEK-3000-HV Oring diode has the built-in active current sharing function to support max. of 8pcs connected in parallel condition to support higher output power. When performing parallel connection, make sure to note the followings:
 - Please connect PAR pins together for current sharing function.
 - Among the parallel connection units, output voltage difference of each PSU should be <math><0.2\text{ VDC}</math> (This can be set via V-adj from the PSU front panel VR).
 - Total output current must not exceed 90% of the rated power in parallel condition. Maximum output current at parallel condition = rated current per unit x number of unit x 0.9.
 - To ensure current share balance, output current of each unit must be >10% vs. the rated output current.
- For Series connection, please find some of the remarks as follow:
 - Max. units for series connection is 2pcs.
 - Total output current must not exceed 90% of the rated power in series condition. Maximum output current at series condition = rated current per unit x 0.9
 - Make sure to isolate all the signals from CN5, except I²C/RS485, Pin 19, 20 and +5VC

MOUNTING INSTRUCTIONS

Recommended Standard Mounting Configurations:

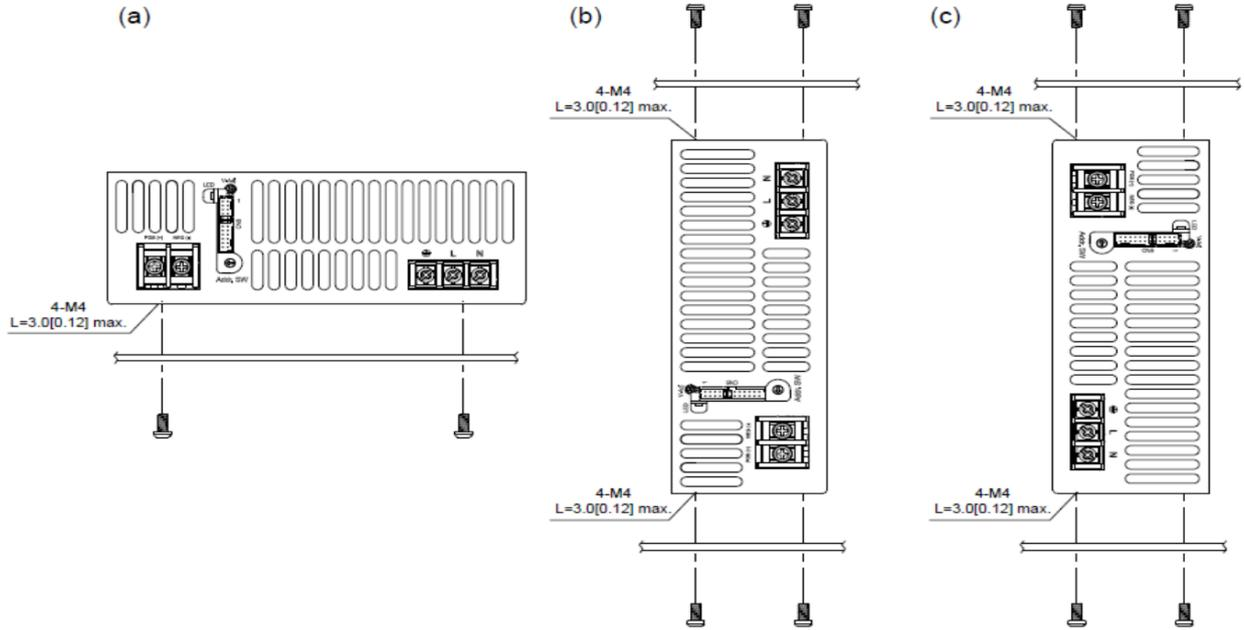

Notes:

1. Recommended screw length is measured from the power supply surface.
2. Ventilating holes on the front and back side panels should not be obstructed. Allow min. 50 mm space for air flow. See below.
3. Recommended torque of M4 mounting screws is 1.27 N · m (13.0 kgf · cm).

More than 50mm

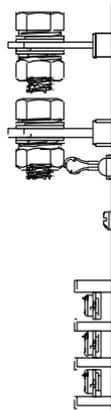

Air flow

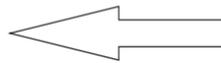

More than 50mm

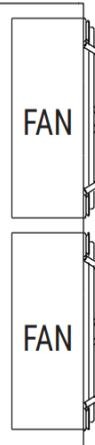

Disclaimer: The information and specifications contained herein are believed to be correct at the time of publication. However, AE accepts no responsibility for consequences arising from reproduction errors or inaccuracies. Specifications are subject to change without notice.



For international contact information,
visit advancedenergy.com.

powersales@aei.com (Sales Support)
productsupport.ep@aei.com (Technical Support)
+1 888 412 7832

ABOUT ADVANCED ENERGY

Advanced Energy (AE) has devoted more than three decades to perfecting power for its global customers. AE designs and manufactures highly engineered, precision power conversion, measurement and control solutions for mission-critical applications and processes.

Our products enable customer innovation in complex applications for a wide range of industries including semiconductor equipment, industrial, manufacturing, telecommunications, data center computing, and medical. With deep applications know-how and responsive service and support across the globe, we build collaborative partnerships to meet rapid technological developments, propel growth for our customers, and innovate the future of power.

PRECISION | POWER | PERFORMANCE | TRUST

Specifications are subject to change without notice. Not responsible for errors or omissions. ©2025 Advanced Energy Industries, Inc. All rights reserved. Advanced Energy®, and AE® are U.S. trademarks of Advanced Energy Industries, Inc.