

ARTESYN LCM300 SERIES

300 Watts Bulk Front End



PRODUCT DESCRIPTION

Advanced Energy's Artesyn LCM300 series provide for a very wide range of AC-DC embedded power requirement. Featuring high build quality with robust screw terminals, long life, and typical full-load efficiency of greater than 91%, these units are ideal for use in industrial and medical applications. They are backed by a comprehensive set of industrial and medical safety approvals and certificates. Variable-speed 'Smart Fans' draw on software controls developed by Advanced Energy to match fan speed to the unit's cooling requirement and load current. Slowing the fan not only saves power but also reduces wear, thus extending its life.

SPECIAL FEATURES

- 310W output power (360W at 45 °C for 24V and 36V models)
- Low cost
- 1.61" x 4.0" x 7.0"
- 7.1 watts per cubic inch
- Industrial/medical safety
- -40 °C to +70 °C with derating
- Optional 5V@2A housekeeping
- High efficiency: 91% @ 230Vac
- Variable speed "smart fans"
- DSP controlled
- PMBus compliant
- Conformal coat optional
- ±20% adjustment range
- Margin programming
- OR-ing FET
- EMI class B
- EN61000 Immunity

- Supports redundant operation

COMPLIANCE

- EMI Class B
- EN61000 Immunity
- RoHS 3
- PMBus

SAFETY

- UL 62368-1
- TUV 62368-1
- CSA 62368-1
- China CCC
- CB Report
- UKCA Mark

AT A GLANCE

Total Power

300 Watts

Input Voltage

90 to 264 Vac

of Outputs

Single



MODEL NUMBERS

Standard	Output Voltage	Minimum Load	Maximum Load	Adjustment Range	Maximum Power
LCM300L	12Vdc	0A	25.0A	9.6-14.4V	310W
LCM300N	15Vdc	0A	20.0A	14.25-19.5V	310W
LCM300Q	24Vdc	0A	14.5A	19.2-28.8V	360W ¹
LCM300U	36Vdc	0A	9.7A	28.8-43.2V	360W ¹
LCM300W	48Vdc	0A	6.3A	43.0-60.0V	310W

Note 1 - When operating temperature does not exceed 45°C, the power supply can continuous deliver up to 360W, includes 5V@2A standby power if the optional standby output is available.

Options

Ordering information about LCMXXXXY-A-B-C-###:

A- Input Termination(T - Terminal Block)

B- Acoustic Noise(Blank = Standard)

C- Option Codes:

Blank = No options

1 = Conformal coat

4 = 5V Standby

5 = Opt 1 + 4

ELECTRICAL SPECIFICATIONS

Absolute Maximum Ratings

Stress in excess of those listed in the “Absolute Maximum Ratings” may cause permanent damage to the power supply. These are stress ratings only and functional operation of the unit is not implied at these or any other conditions above those given in the operational sections of this TRN. Exposure to any absolute maximum rated condition for extended periods may adversely affect the power supply’s reliability.

Table 1. Absolute Maximum Ratings							
Parameter	Model	Symbol	Min	Typ	Max	Unit	
Input Voltage	AC continuous operation	All models	$V_{IN,AC}$	90	-	264	Vac
	DC continuous operation	All models	$V_{IN,DC}$	127	-	374	Vdc
Maximum Output Power (Main + Stand-by)	LCM300L	$P_{O,max}$	-	-	310	W	
	LCM300N		-	-	310	W	
	LCM300Q		-	-	360 ¹	W	
	LCM300U		-	-	360 ¹	W	
	LCM300W		-	-	310	W	
Isolation Voltage(Qualification)	All models		-	-	4000	Input to outputs(2xMOPP)	Vac
						Input to safety ground(1XMOPP)	Vdc
						Outputs to safety ground(1XMOPP)	Vdc
Isolation Voltage(Production)	All models		-	-	1800	Input to outputs(2xMOPP)	Vac
						Input to safety ground(1XMOPP)	Vac
						Outputs to safety ground(1XMOPP)	Vac
Ambient Operating Temperature	All models	T_A	-40	-	+70 ²	°C	
Storage Temperature	All models	T_{STG}	-40	-	+85	°C	
Humidity (non-condensing)	Operating	All models		-	90	%	
	Non-operating	All models					20
Altitude	Operating	All models		-	10,000	feet	
	Non-operating	All models					-

Note1 - Deliver up to 360 watts when operating temperature does not exceed 45°C
 Note2 - Line derating each output at 2.5% per degree C from 50°C to 70°C.

ELECTRICAL SPECIFICATIONS

Table 2. Input Specifications						
Parameter	Condition	Symbol	Min	Typ	Max	Unit
Operating Input Voltage, AC	All	$V_{IN,AC}$	90	115/230	264	Vac
Input AC Frequency	All	$f_{IN,AC}$	47	50/60	63	Hz
Maximum Input Current ($I_O = I_{O,max}$, $I_{SB} = I_{SB,max}$)	$V_{IN,AC} = 100Vac$	$I_{IN,max}$	-	-	5	A
No Load Input Current ($V_O = On$, $I_O = 0A$, $I_{SB} = 0A$)	$V_{IN,AC} = 90Vac$ $V_{IN,AC} = 264Vac$	$I_{IN,no-load}$	- -	- -	100 200	mA mA
No Load Input Power ($V_O = On$, $I_O = 0A$, $I_{SB} = 0A$)	$V_{IN,AC} = 90Vac$ $V_{IN,AC} = 264Vac$	$P_{IN,no-load}$	- -	- -	6 8	W W
Harmonic Line Currents	All	THD	Per IEC1000-3-2			
Power Factor	$I_O = I_{O,max}$ $V_{IN,AC} = 110Vac$	PF	-	0.98	-	
Startup Surge Current (Inrush) @ 25°C	$V_{IN,AC} = 264Vac$	$I_{IN,surge}$	-	-	20	A_{PK}
Input Fuse	Internal, L and N 8A,250Vac rated		-	-	8	A
Input AC Low Line Start-up Voltage	$I_O = I_{O,max}$	$V_{IN,AC-start}$	80	-	90	Vac
Input AC Undervoltage Lockout Voltage	$I_O = I_{O,max}$	$V_{IN,AC-stop}$	75	-	85	Vac
PFC Switching Frequency	All	$f_{SW,PFC}$	64	-	76	KHz
Efficiency ($T_A = 25^\circ C$, forced air cooling)	$V_{IN,AC} = 230Vac$ $I_O = I_{O,max}$	η	-	91	-	%
Turn On Delay Resistive Load	$V_{IN,AC} = 90Vac$ $I_O = I_{O,max}$	$t_{Turn-On}$	-	-	3	Sec
Leakage Current to safety ground	IEC test method	$I_{IN,leakage}$	-	-	0.5	mA
	UL test method	$I_{IN,leakage}$	-	-	0.3	mA

ELECTRICAL SPECIFICATIONS

Output Specifications

Table 3. Output Specifications							
Parameter		Condition	Symbol	Min	Typ	Max	Unit
Factory Set Voltage	LCM300L	$I_O = 0A$	$V_{O,Factory}$	11.94	12.00	12.06	V
	LCM300N			14.93	15	15.07	
	LCM300Q			23.88	24	24.12	
	LCM300U			35.82	36	36.18	
	LCM300W			47.76	48	48.24	
Output Adjust Range	LCM300L	$I_O = 0A$	V_O	9.6	-	14.4	V
	LCM300N			14.25	-	19.5	
	LCM300Q			19.2	-	28.8	
	LCM300U			28.8	-	43.2	
	LCM300W			43.0	-	60.0	
Total Regulation		Inclusive of line, load temperature change, warm-up drift and dynamic load	$\%V_O$	-2.0	-	+2.0	%
			V_{SB}	4.8	-	5.4	V
Output Ripple, pk-pk	LCM300L LCM300N LCM300Q LCM300U LCM300W	See note 1, note 2 and note 3	V_O	-	-	120 150 240 360 480	mV_{PK-PK}
	All models		V_{SB}	-	-	100	mV_{PK-PK}
Output Current	LCM300L LCM300N LCM300Q LCM300U LCM300W	All	I_O	0 0 0 0 0	- - - - -	25.0 20.0 12.5 8.4 6.3	A
	All models		I_{SB}	0	-	2	A
Maximum Output Power, continuous	LCM300L LCM300N LCM300Q LCM300U LCM300W	All	$P_{O,maxCC}$	0	-	310	W
				0	-	310	
				0	-	360	
				0	-	360	
				0	-	310	
Ripple Switching Frequency		All	$f_{SW,DC-DC}$	115	-	125	KHz
Hold Up Time		See note 4	$t_{Hold-Up}$	20	-	-	mSec
Dynamic Response - Peak Deviation		50% to 100% of $I_{O,max}$ load change Slew rate = 1A/ μ s	$\pm\%V_O$	-	-	2	%
Dynamic Response - Setting Time	t_s		-	-	300	μ Sec	
Load Capacitance		Start up	V_O	0	-	1500	μ F
			V_{SB}	0	-	270	μ F
Number of Parallel Units		All		-	-	10	Units

Note 1 - Measure with a 0.1 μ F ceramic capacitor in parallel with a 10 μ F tantalum capacitor using a 20MHz bandwidth limited oscilloscope.

Note 2 - In case if voltage is adjusted above nominal setting, ripple expected is 1% of output voltage.

Note 3 - Ripple noise at extreme low temperature (below 0°C) is expected higher until unit get stabilized due to ESR change of the E-Caps.

Note 4 - Adjusting the output to higher tolerance (i.e. 28.8V which is the +20% adjustment range of 24V Nominal) will give a typical hold up of 10msec.

ELECTRICAL SPECIFICATIONS

System Timing Specifications

Table 4. Specifications					
Label	Parameter	Min	Typ	Max	Unit
T1	Delay from AC Input being applied to main output voltages being within regulation.	-	-	3000	mSec
T2	There is a continuous ramp of output voltage from 10% to 95% of its final set point within the regulation band, while loaded.	-	-	300	mSec
T3	Delay from main output within regulation to G_DCOK_C signal assertion (going low).	-	-	500	mSec
T4	Delay from loss of AC input to G_ACOK_C going to high.	-	-	10	mSec
T5	Hold up time - time all output voltages, including V_{SB} , stay within regulation after loss of Input AC. Main output set at nominal voltage setting.	20	-	-	mSec
T6	Delay from G_DCOK_C signal de-assertion (going high) to main output dropping to less than the lower trimming range (-20% of the nominal output).	1	-	-	mSec
T7	Delay from INH_EN active to output voltages within regulation limits.		-	2000	mSec
T8	Delay from INH_EN de-active to G_DCOK_C de-asserted (going high).	-	-	2	mSec

ELECTRICAL SPECIFICATIONS

System Timing Diagram

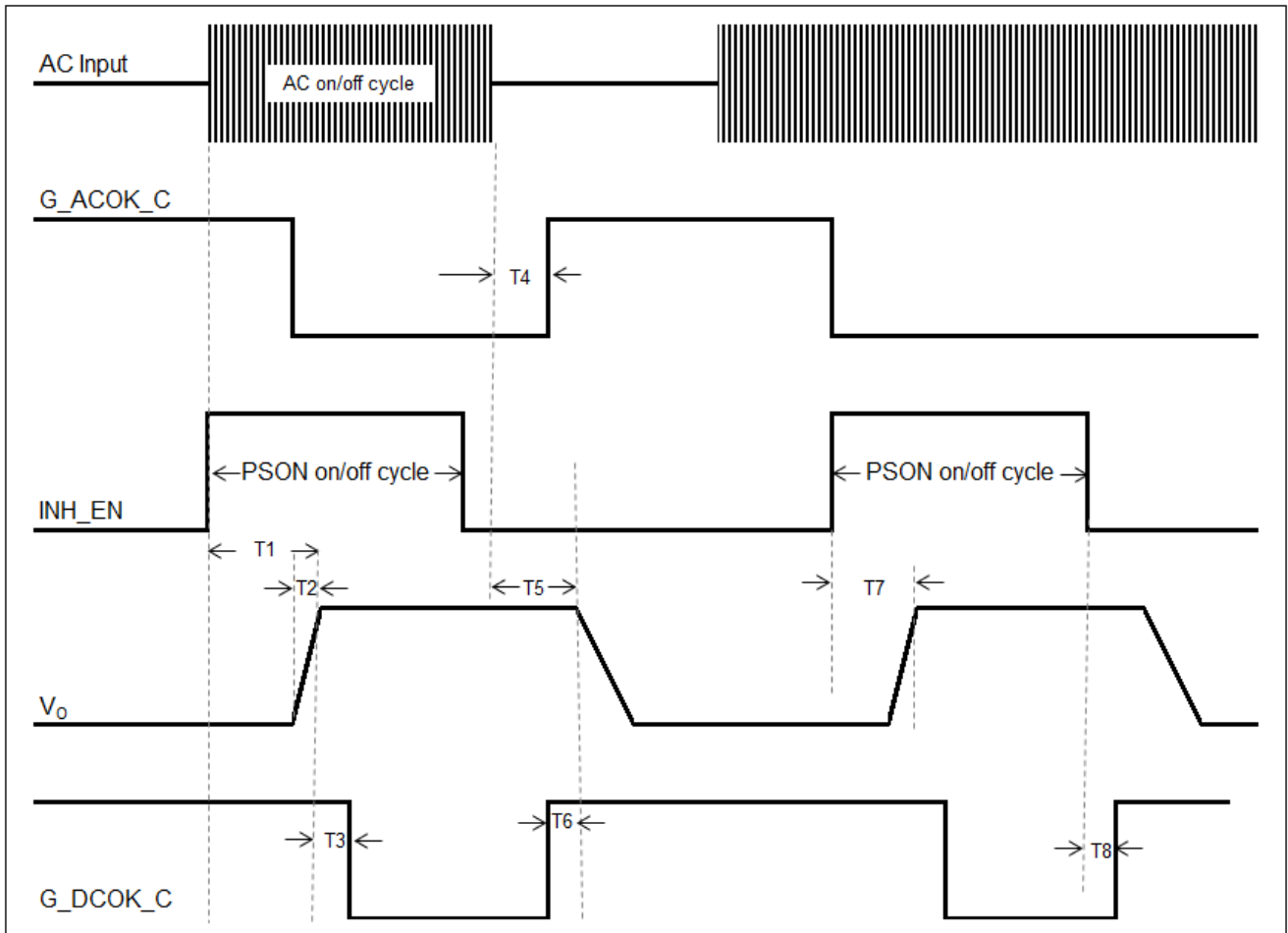

ELECTRICAL SPECIFICATIONS

LCM300L Performance Curves



Figure 1: LCM300L Turn-on delay via AC mains
 Vin = 90Vac Load: I_O = 25A (12V), I_{SB} = 2A (5V)
 Ch 1: AC Mains Ch 2: V_{SB} Ch 3: V_O Ch 4: G_DCOK_C



Figure 2: LCM300L Turn-on delay via INH_EN
 Vin = 90Vac Load: I_O = 25A (12V), I_{SB} = 2A (5V)
 Ch 1: AC Mains Ch 2: INH_EN Ch 3: V_O Ch 4: G_DCOK_C



Figure 3: LCM300L Hold-up Time
 Vin = 90Vac / 47Hz / 0° Load: I_O = 25A (12V), I_{SB} = 2A (5V)
 Ch 1: AC Mains Ch 2: V_{SB} Ch 3: V_O Ch 4: G_DCOK_C



Figure 4: LCM300L Hold-up Time
 Vin = 264Vac / 60Hz / 0° Load: I_O = 25A (12V), I_{SB} = 2A (5V)
 Ch 1: AC Mains Ch 2: V_{SB} Ch 3: V_O Ch 4: G_DCOK_C

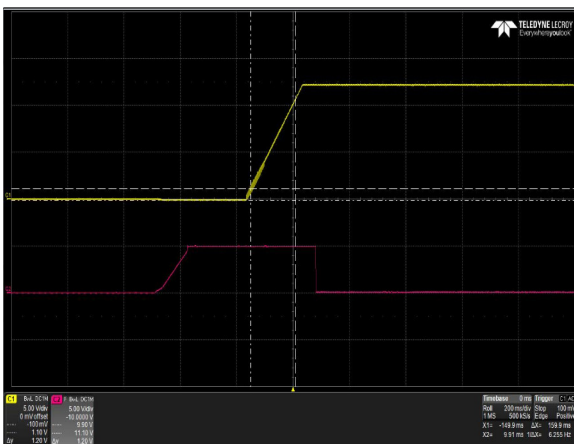

Figure 5: LCM300L Output Voltage Startup Characteristic
 Vin = 90Vac Load: I_O = 25A (12V), I_{SB} = 2A (5V)
 Ch 1: V_O Ch 2: G_DCOK_C

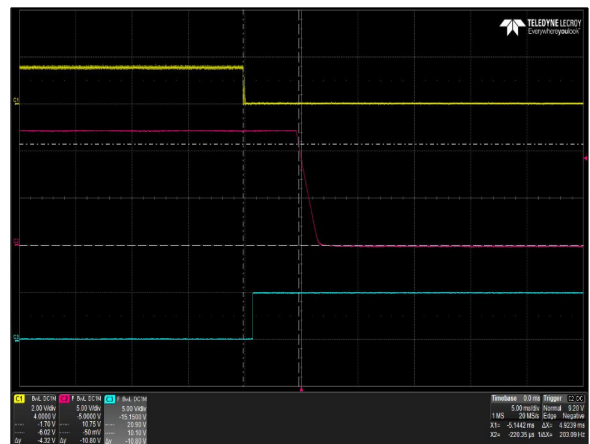

Figure 6: LCM300L Turn Off Characteristic via INH_EN
 Load: I_O = 25A (12V), I_{SB} = 2A (5V)
 Ch 1: INH_EN Ch 2: V_O Ch 3: G_DCOK_C

ELECTRICAL SPECIFICATIONS

LCM300L Performance Curves



Figure 7: LCM300L Transient Response - V_O Deviation
 50% to 100% load change 1A/uS slew rate $V_{in} = 230V_{ac}$
 Ch 1: V_O Ch 2: I_O



Figure 8: LCM300L Transient Response - V_O Deviation
 100% to 50% load change 1A/uS slew rate $V_{in} = 230V_{ac}$
 Ch 1: V_O Ch 2: I_O

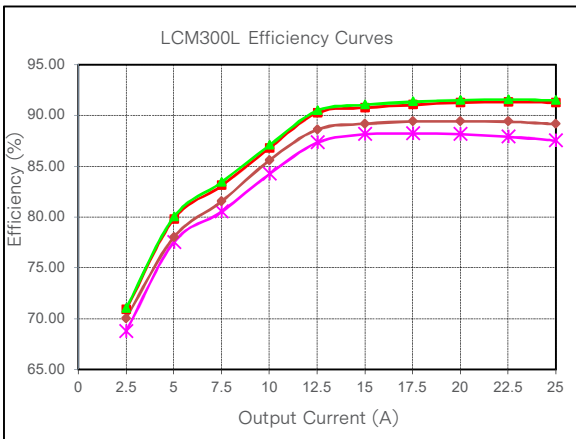

Figure 9: LCM300L Efficiency Curve @ 25°C
 — 90Vac — 115Vac — 230Vac — 264Vac
 Loading: $I_{o_main} = 10\%I_{o_max}$ increment to 25A, $I_{SB} = 0A$ (5V)

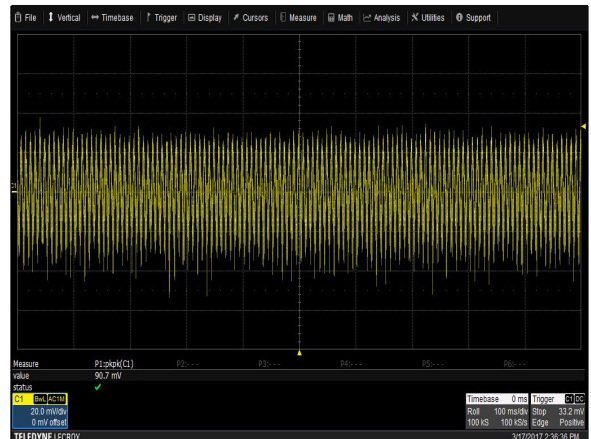

Figure 10: LCM300L Ripple and Noise Measurement
 $V_{in} = 90V_{ac}$ Load: $I_O = 25A$ (12V), $I_{SB} = 2A$ (5V)
 Ch 1: V_O

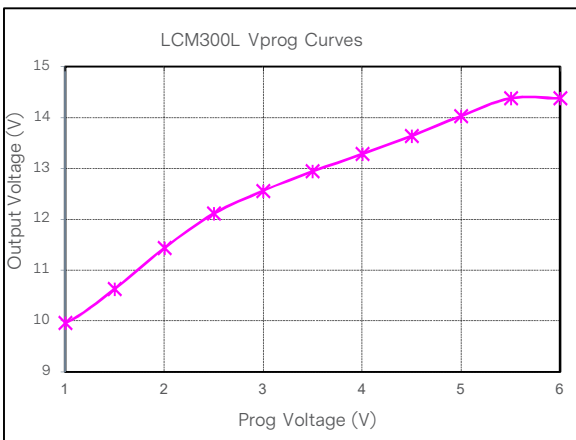

Figure 11: LCM300L Output Voltage Adjustment by Vprog @ 25°C
 — 115Vac
 Loading: $I_O = 0A$ (12V), $I_{SB} = 0A$ (5V)

ELECTRICAL SPECIFICATIONS

LCM300N Performance Curves

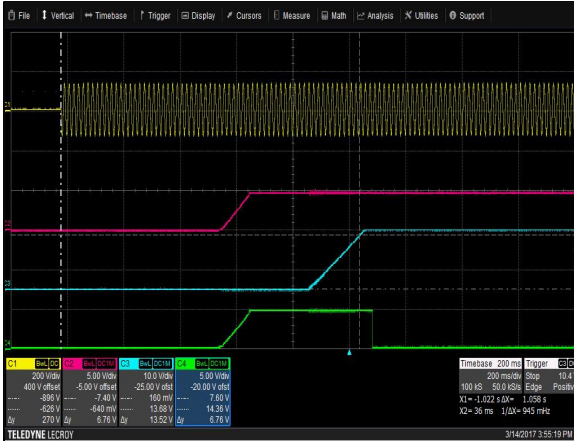

Figure 12: LCM300N Turn-on delay via AC mains
 Vin = 90Vac Load: IO = 20A (15V), ISB = 2A (5V)
 Ch 1: AC Mains Ch 2: VSB Ch 3: VO Ch 4: G_DCOK_C



Figure 13: LCM300N Turn-on delay via INH_EN
 Vin = 90Vac Load: IO = 20A (15V), ISB = 2A (5V)
 Ch 1: AC Mains Ch 2: INH_EN Ch 3: VO Ch 4: G_DCOK_C



Figure 14: LCM300N Hold-up Time
 Vin = 90Vac / 47Hz / 0° Load: IO = 20A (15V), ISB = 2A (5V)
 Ch 1: AC Mains Ch 2: VSB Ch 3: VO Ch 4: G_DCOK_C

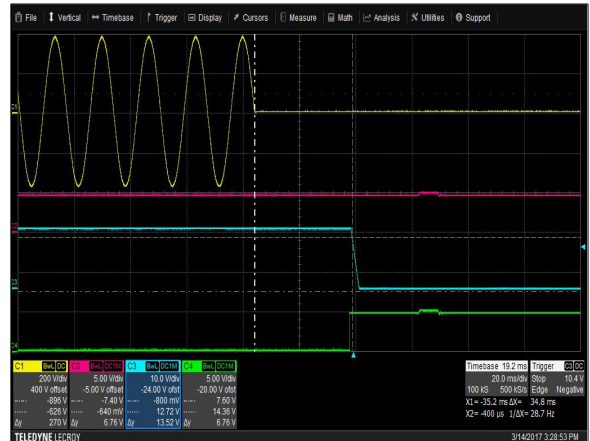

Figure 15: LCM300N Hold-up Time
 Vin = 264Vac / 60Hz / 0° Load: IO = 20A (15V), ISB = 2A (5V)
 Ch 1: AC Mains Ch 2: VSB Ch 3: VO Ch 4: G_DCOK_C

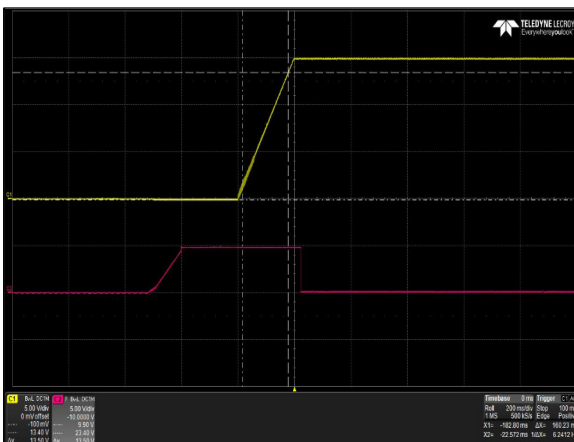

Figure 16: LCM300N Output Voltage Startup Characteristic
 Vin = 90Vac Load: IO = 20A (15V), ISB = 2A (5V)
 Ch 1: VO Ch 2: G_DCOK_C

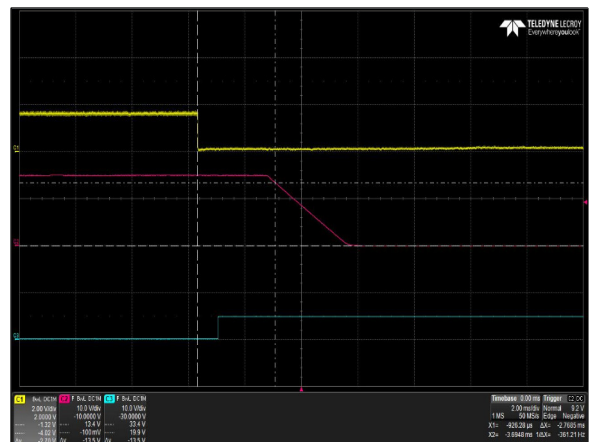

Figure 17: LCM300N Turn Off Characteristic via INH_EN
 Load: IO = 20A (15V), ISB = 2A (5V)
 Ch 1: INH_EN Ch 2: VO Ch 3: G_DCOK_C

ELECTRICAL SPECIFICATIONS

LCM300N Performance Curves



Figure 18: LCM300N Transient Response - Vo Deviation
50% to 100% load change 1A/uS slew rate Vin = 230Vac
Ch 1: Vo Ch 2: Io



Figure 19: LCM300N Transient Response - Vo Deviation
100% to 50% load change 1A/uS slew rate Vin = 230Vac
Ch 1: Vo Ch 2: Io

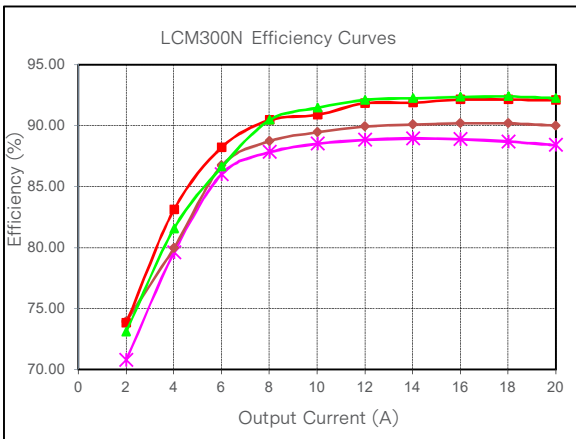

Figure 20: LCM300N Efficiency Curve @ 25°C
 ◆ 90Vac ◆ 115Vac ◆ 230Vac ◆ 264Vac
 Loading: $I_{O_main} = 10\%I_{O_max}$ increment to 20A, $I_{SB} = 0A$ (5V)

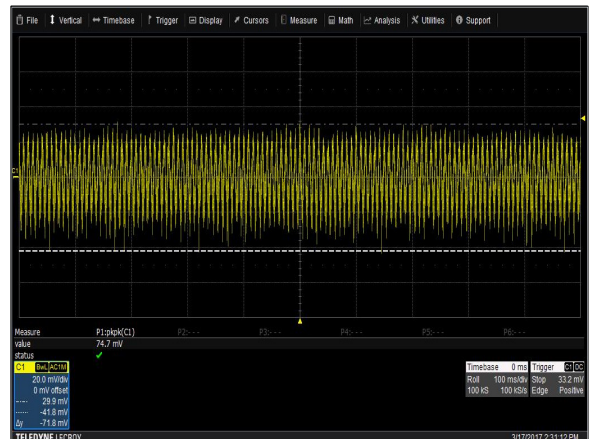

Figure 21: LCM300N Ripple and Noise Measurement
Vin = 90Vac Load: $I_O = 20A$ (15V), $I_{SB} = 2A$ (5V)
Ch 1: Vo

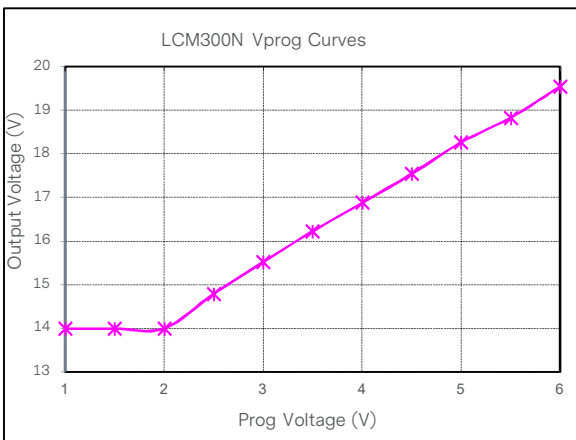
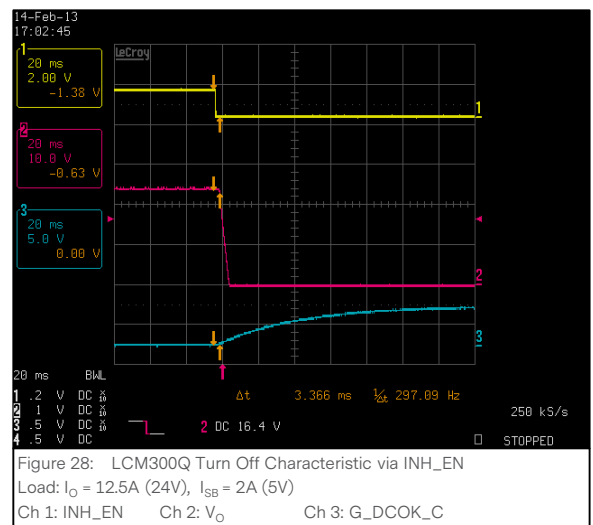
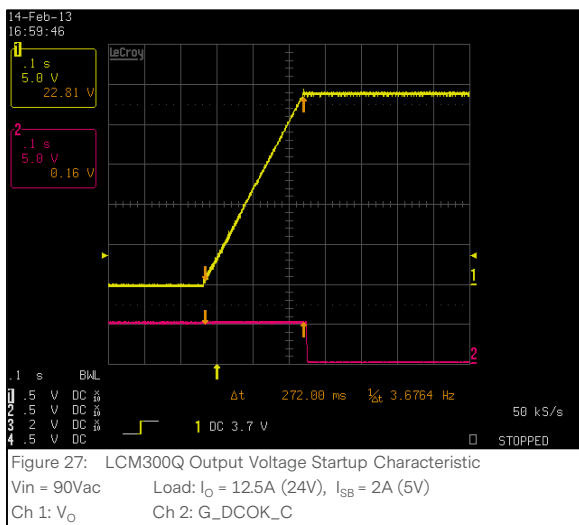
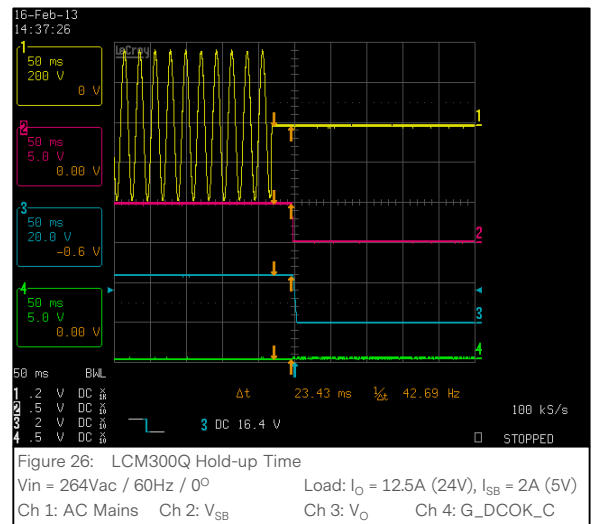
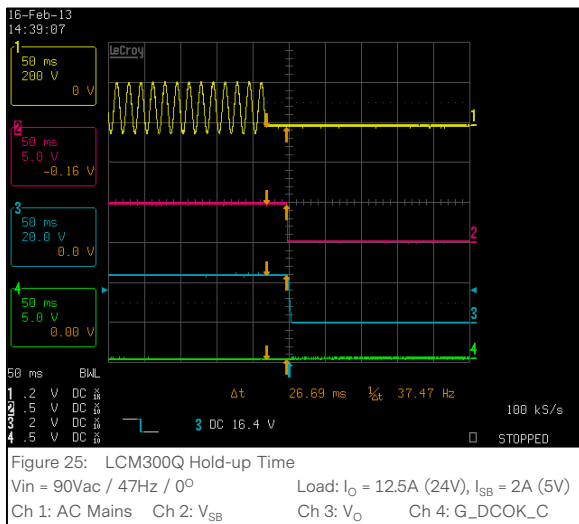
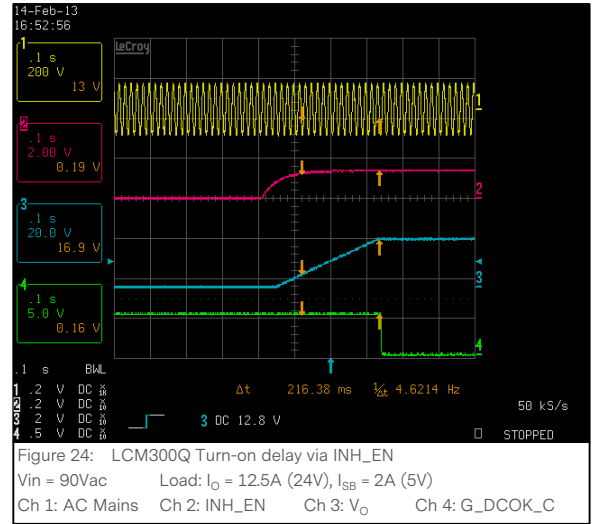
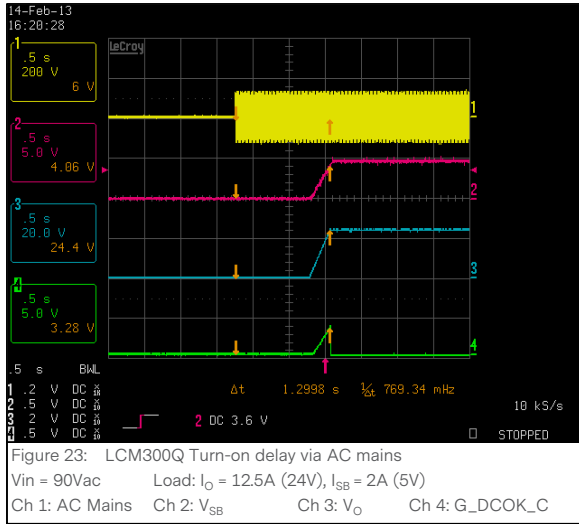

Figure 22: LCM300N Output Voltage Adjustment by Vprog @ 25°C
◆ 115Vac
Loading: $I_O = 0A$ (15V), $I_{SB} = 0A$ (5V)

ELECTRICAL SPECIFICATIONS

LCM300Q Performance Curves



ELECTRICAL SPECIFICATIONS

LCM300Q Performance Curves

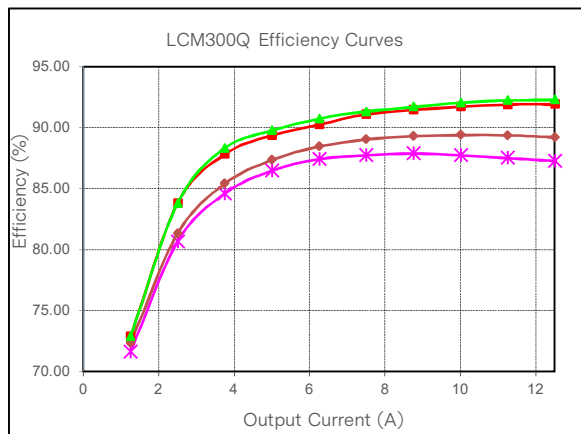
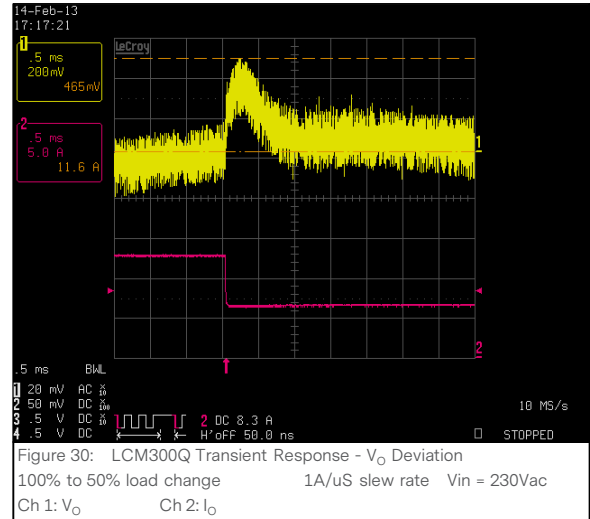
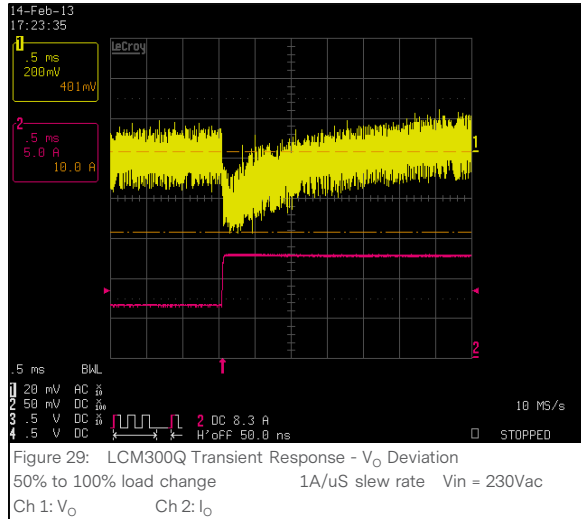

Figure 31: LCM300Q Efficiency Curve @ 25°C
 * 90Vac * 115Vac * 230Vac * 264Vac
 Loading: $I_{O_main} = 10\%I_{O_max}$ increment to 12.5A, $I_{SB} = 0A$ (5V)

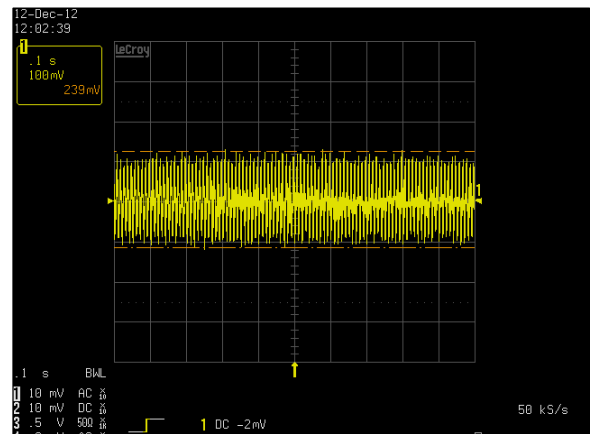

Figure 32: LCM300Q Ripple and Noise Measurement
 $V_{in} = 90V_{ac}$ Load: $I_O = 12.5A$ (24V), $I_{SB} = 2A$ (5V)
 Ch 1: V_O

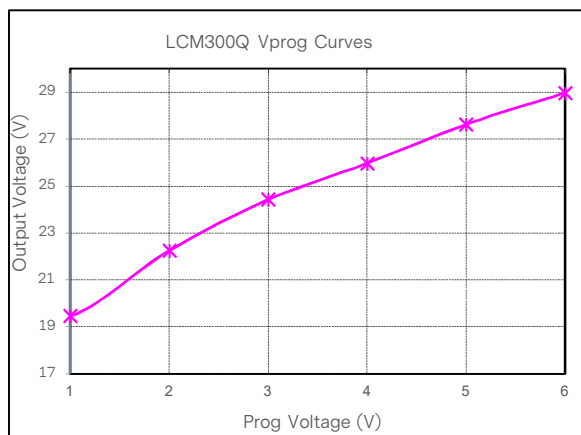

Figure 33: LCM300Q Output Voltage Adjustment by V_{prog} @ 25°C
 * 115Vac
 Loading: $I_O = 0A$ (24V), $I_{SB} = 0A$ (5V)

ELECTRICAL SPECIFICATIONS

LCM300U Performance Curves

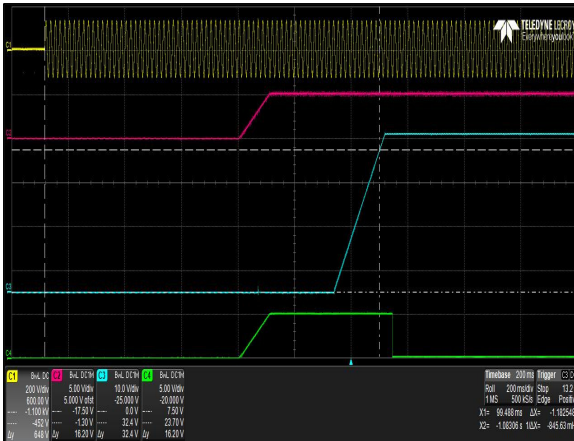

Figure 34: LCM300U Turn-on delay via AC mains
 Vin = 90Vac Load: Io = 8.4A (36V), I_{SB} = 2A (5V)
 Ch 1: AC Mains Ch 2: V_{SB} Ch 3: Vo Ch 4: G_DCOK_C



Figure 35: LCM300U Turn-on delay via INH_EN
 Vin = 90Vac Load: Io = 8.4A (36V), I_{SB} = 2A (5V)
 Ch 1: AC Mains Ch 2: INH_EN Ch 3: Vo Ch 4: G_DCOK_C

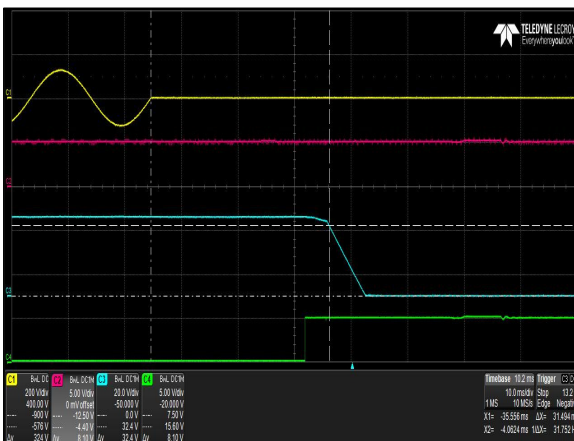

Figure 36: LCM300U Hold-up Time
 Vin = 90Vac / 47Hz / 0° Load: Io = 8.4A (36V), I_{SB} = 2A (5V)
 Ch 1: AC Mains Ch 2: V_{SB} Ch 3: Vo Ch 4: G_DCOK_C

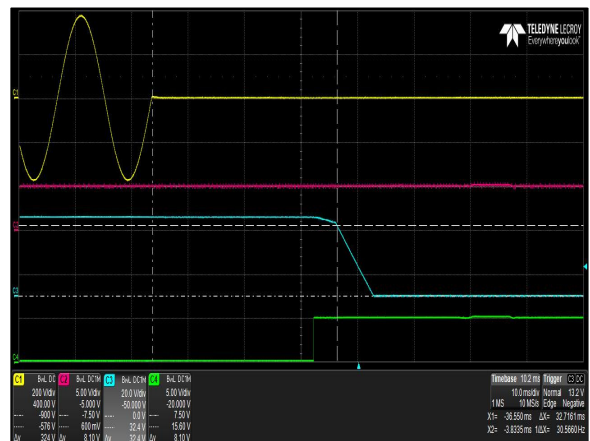

Figure 37: LCM300U Hold-up Time
 Vin = 264Vac / 60Hz / 0° Load: Io = 8.4A (36V), I_{SB} = 2A (5V)
 Ch 1: AC Mains Ch 2: V_{SB} Ch 3: Vo Ch 4: G_DCOK_C

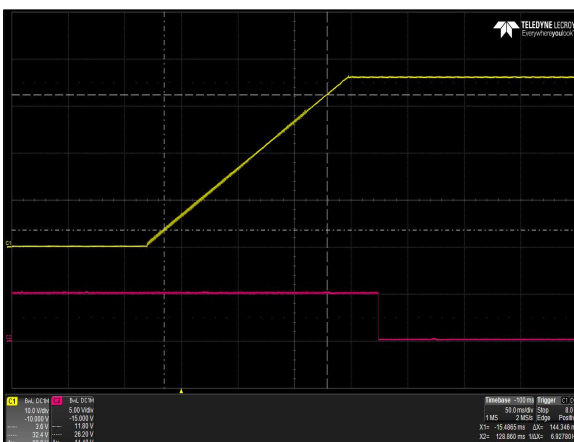

Figure 38: LCM300U Output Voltage Startup Characteristic
 Vin = 90Vac Load: Io = 8.4A (36V), I_{SB} = 2A (5V)
 Ch 1: Vo Ch 2: G_DCOK_C

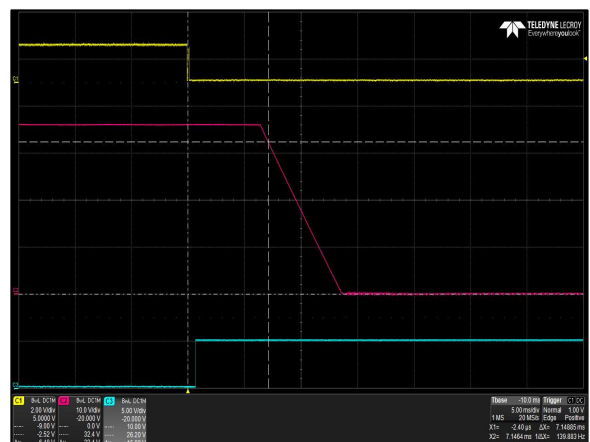

Figure 39: LCM300U Turn Off Characteristic via INH_EN
 Load: Io = 8.4A (36V), I_{SB} = 2A (5V)
 Ch 1: INH_EN Ch 2: Vo Ch 3: G_DCOK_C

ELECTRICAL SPECIFICATIONS

LCM300U Performance Curves

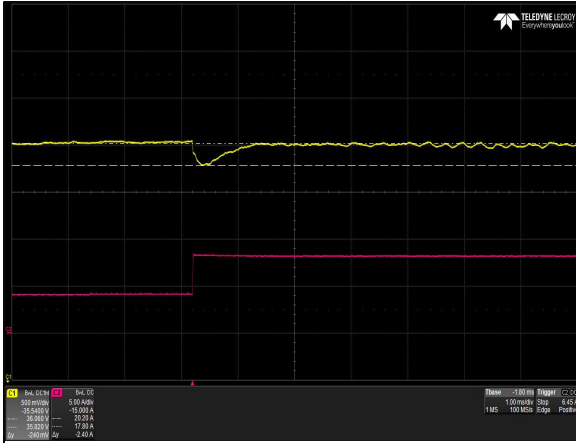

Figure 40: LCM300U Transient Response - Vo Deviation
50% to 100% load change 1A/uS slew rate Vin = 230Vac
Ch 1: Vo Ch 2: Io

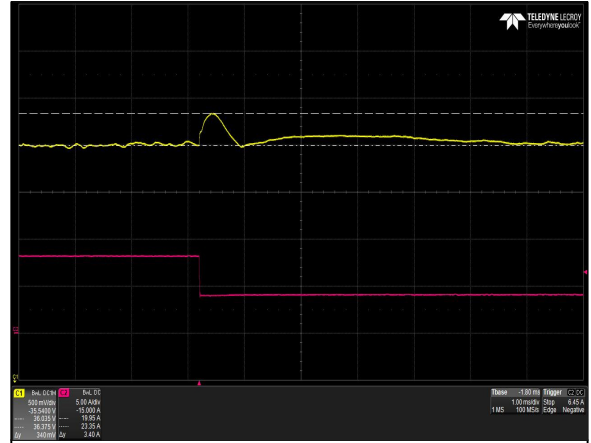

Figure 41: LCM300U Transient Response - Vo Deviation
100% to 50% load change 1A/uS slew rate Vin = 230Vac
Ch 1: Vo Ch 2: Io

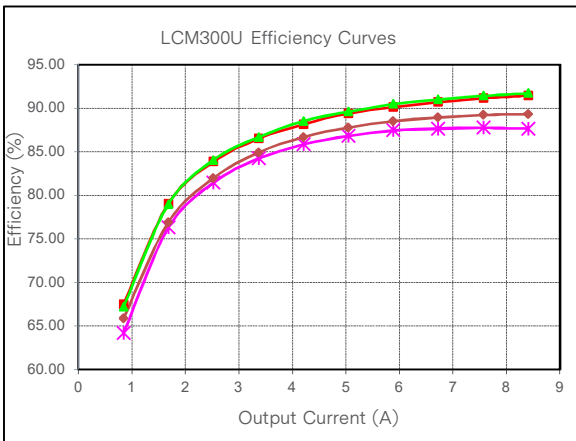

Figure 42: LCM300U Efficiency Curve @ 25°C
— 90Vac — 115Vac — 230Vac — 264Vac
Loading: $I_{o_main} = 10\%I_{o_max}$ increment to 8.4A, $I_{SB} = 0A$ (5V)

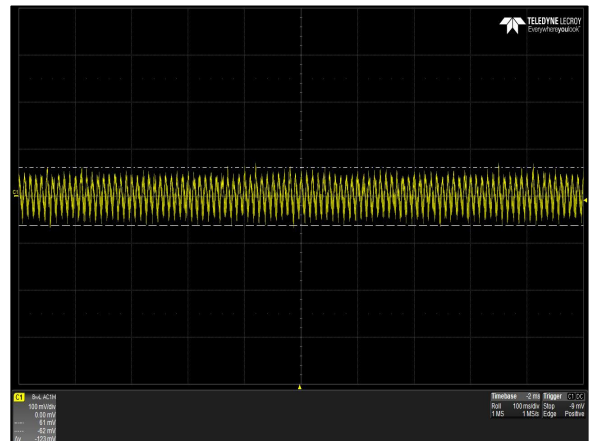

Figure 43: LCM300U Ripple and Noise Measurement
Vin = 90Vac Load: Io = 8.4A (36V), $I_{SB} = 2A$ (5V)
Ch 1: Vo

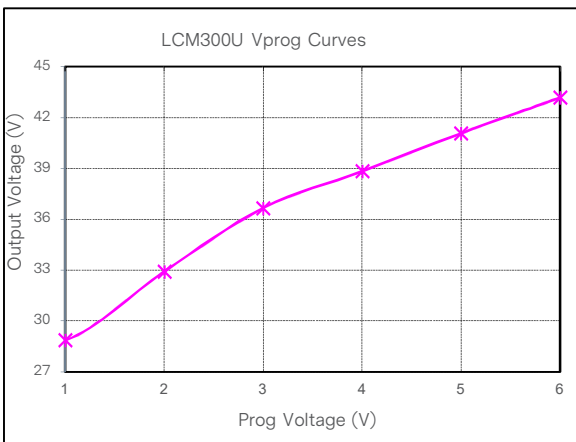
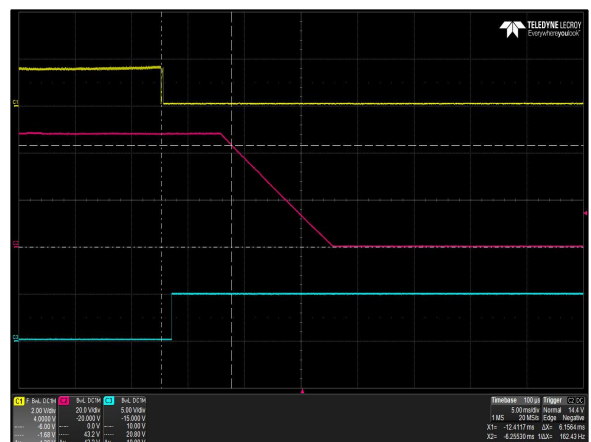
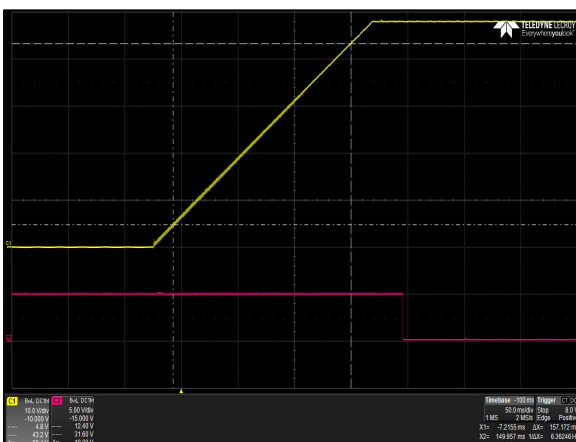
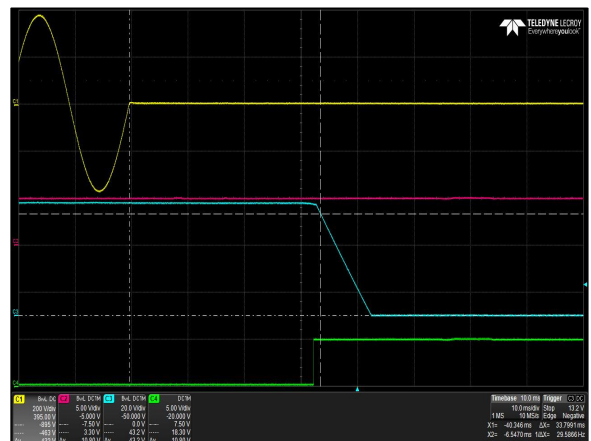
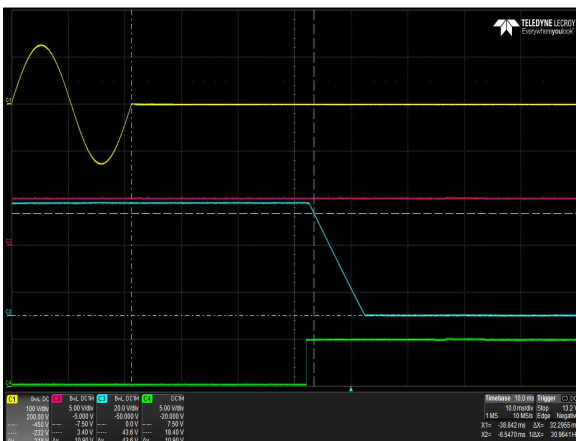
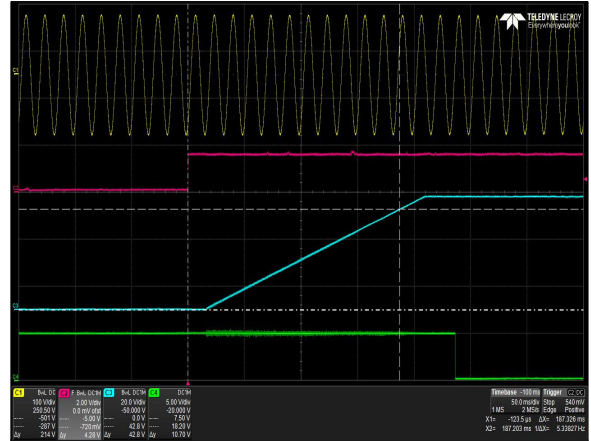
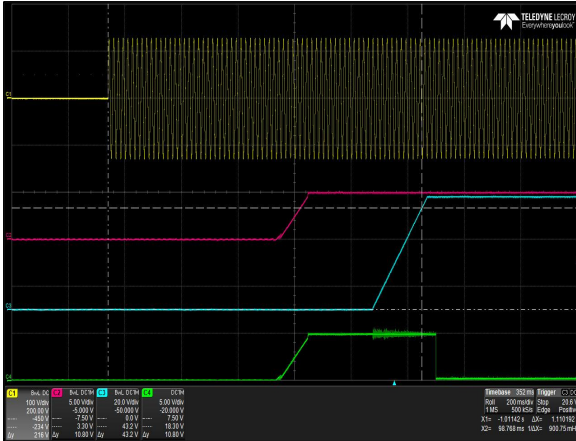

Figure 44: LCM300U Output Voltage Adjustment by Vprog @ 25°C
— 115Vac
Loading: $I_o = 0A$ (36V), $I_{SB} = 0A$ (5V)

ELECTRICAL SPECIFICATIONS

LCM300W Performance Curves



ELECTRICAL SPECIFICATIONS

LCM300W Performance Curves

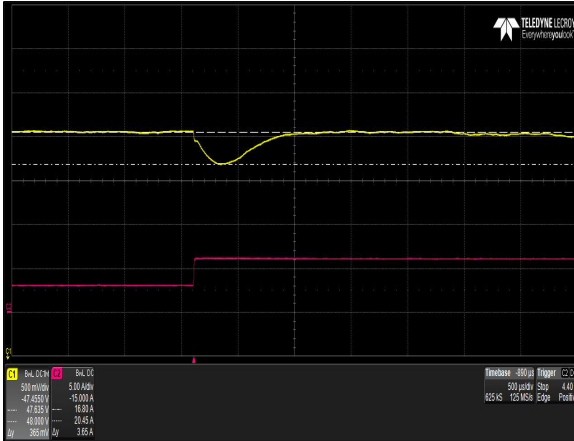

Figure 51: LCM300W Transient Response - Vo Deviation
50% to 100% load change 1A/uS slew rate Vin = 230Vac
Ch 1: Vo Ch 2: Io

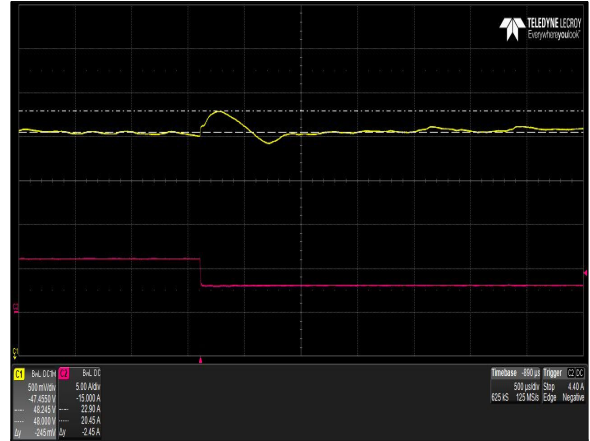

Figure 52: LCM300W Transient Response - Vo Deviation
100% to 50% load change 1A/uS slew rate Vin = 230Vac
Ch 1: Vo Ch 2: Io

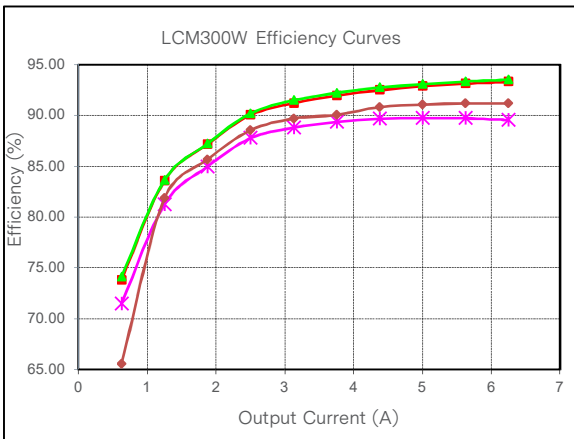

Figure 53: LCM300W Efficiency Curve @ 25°C
Loading: $I_{o_main} = 10\%I_{o_max}$ increment to 6.3A, $I_{SB} = 0A$ (5V)

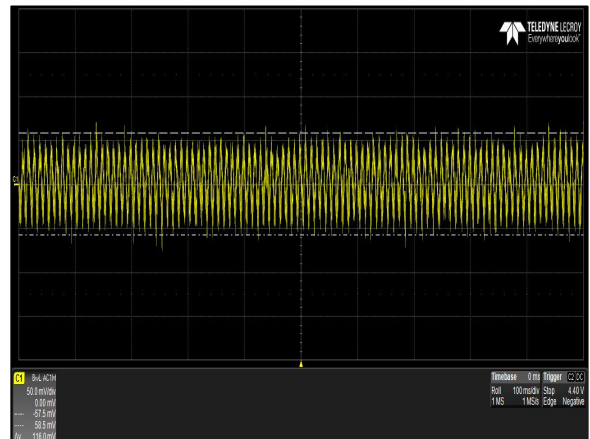

Figure 54: LCM300W Ripple and Noise Measurement
Vin = 90Vac Load: Io = 6.3A (48V), I_{SB} = 2A (5V)
Ch 1: Vo

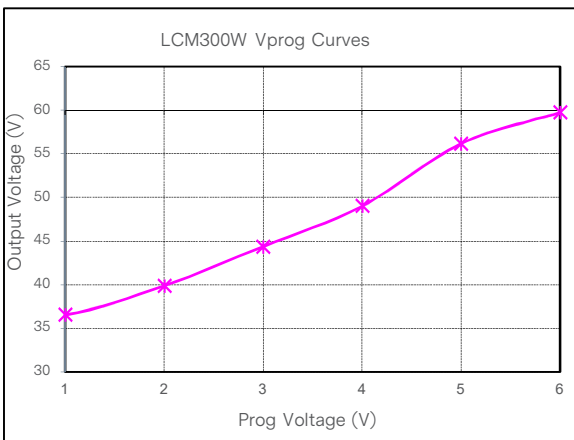

Figure 55: LCM300W Output Voltage Adjustment by Vprog @ 25°C
Loading: $I_o = 0A$ (48V), $I_{SB} = 0A$ (5V)

ELECTRICAL SPECIFICATIONS

Protection Function Specifications

Input Fuse

LCM300 series are equipped with an internal non user serviceable 8A High Rupturing Capacity (HRC) 250 Vac fuse to IEC 127 for fault protection in both the Line and Neutral input.

Over Voltage Protection (OVP)

The power supply latches off during output overvoltage with the AC line recycled to reset the latch.

Parameter	Min	Typ	Max	Unit
V _O Output Overvoltage	125	/	145	% V _O
V _{SB} Output Overvoltage	110	/	125	% V _O

Over Current Protection (OCP)

LCM300 series include internal current limit circuitry to prevent damage in the event of overload or short circuit. Recovery must be automatic when the overload is removed more than 20secs, if the output current is larger than or equal to 105% of rated load, it will go to hiccup mode. OCP fault on 5V standby output can cause the main output shutdown.

Parameter	Min	Typ	Max	Unit
V _O Output Overcurrent	105	/	145	%I _{O, max}
V _{SB} Output Overcurrent	120	/	170	%I _{SB, max}

Short Circuit Protection (SCP)

A short circuit is defined as less than 0.03 ohm resistance between the output terminals. All outputs shall be protected against short circuit to ground or other outputs. No damage shall result. In the event of short circuit, the power supply must shut down and it will automatically retry within 25 secs. Also, INH_ENA can be used for manual recycle to remove the fault condition and reset the power supply. In the event of short circuit on the optional 5V standby, the whole PSU, including the main output, must shut down. There is automatic recovery within 20secs after fault removal or the input AC can be recycled manually to reset the power supply and remove the fault condition.

Over Temperature Protection (OTP)

The power supply is internally protected against over temperature conditions. When the OTP circuit is activated, the power supply will shut off and will auto-recover once the OTP condition is gone. OTP trip-point at full load is set at a nominal of 55 to 65 °C Ambient Temperature.

MECHANICAL SPECIFICATIONS

Mechanical Outlines (unit:mm)

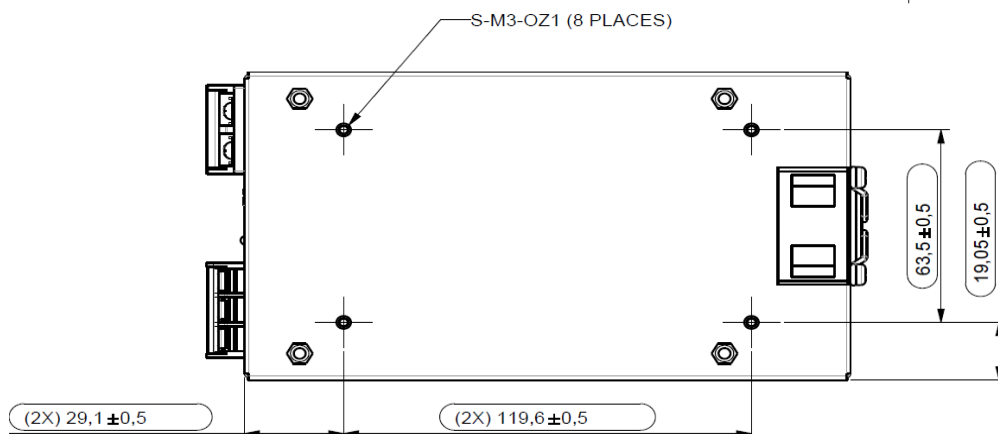
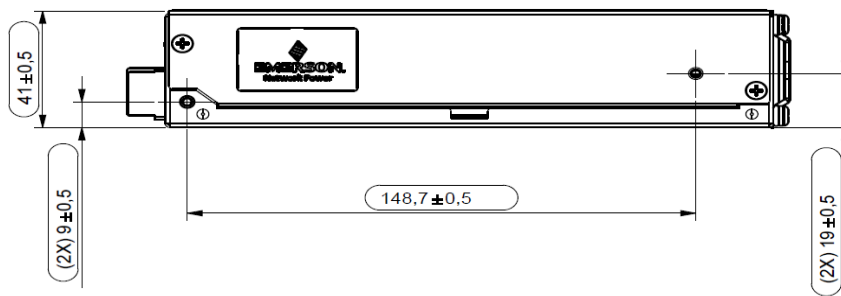
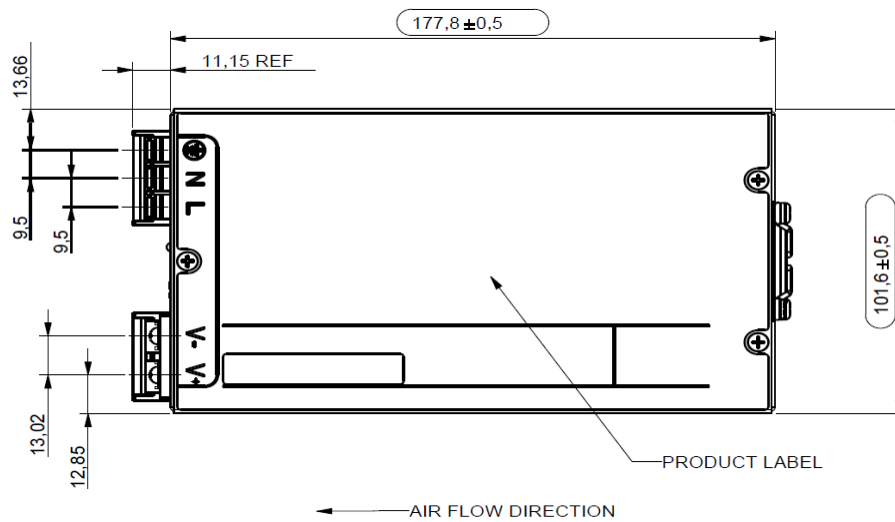
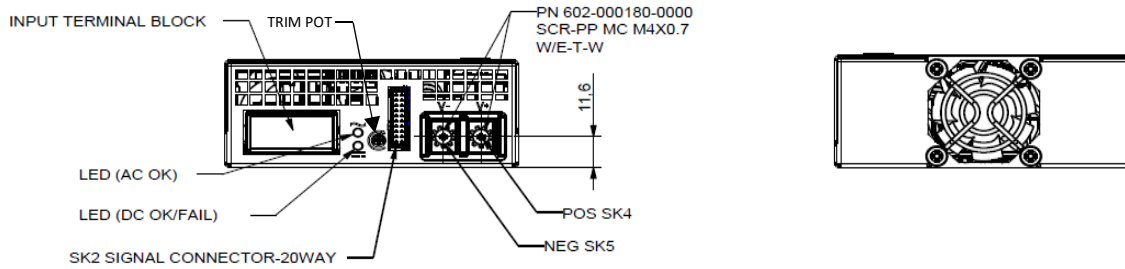

MECHANICAL SPECIFICATIONS

Connector Definitions

AC Input Connector - SK1

L – Live

N – Neutral

⊕ – Ground

Output Connector – SK4&SK5

SK4 – + Main Output (Vo)

SK5 – Main Output Return

Output Connector – SK2

Pin 1 – A2

Pin 2 – -VPROG

Pin 3 – A1

Pin 4 – -VSense

Pin 5 – ISHARE

Pin 6 – A0

Pin 7 – SDA1

Pin 8 – +VPROG

Pin 9 – SCL1

Pin 10 – +Vsense

Pin 11 – 5VSB

Pin 12 – GND

Pin 13 – 5VSB

Pin 14 – G_DCOK_C

Pin 15 – GPIOA6

Pin 16 – G_DCOK_E

Pin 17 – GND

Pin 18 – G_ACOK_C

Pin 19 – INH_EN

Pin 20 – G_ACOK_E

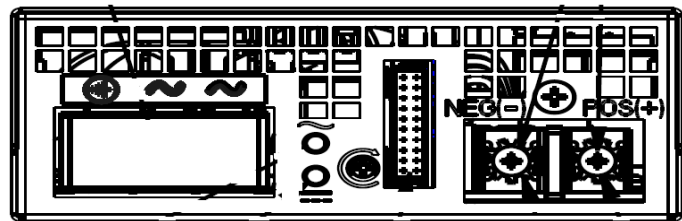

Input Connector

SK2

SK5

SK4

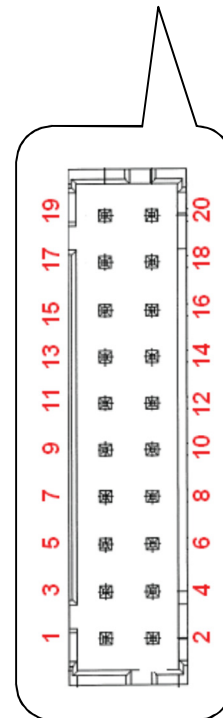

MECHANICAL SPECIFICATIONS

Power / Signal Mating Connectors and Pin Types

Table 5. Mating Connectors for LCM300 Series		
Reference	On Power Supply	Mating Connector or Equivalent
AC Input Connector	DINKLE (PN: DT-4C-B14W-03)	M3.5 screw
SK2	CVILUX (PN: CI0120P1HD0-LF)	LANDWIN (LWE PN: 2050S2000) Housing (LWE PN: 2053T021V) Contact CVILUX (CX PN: CI0120SD000) Housing (CX PN: CI01TD21PE0) Contact
SK4, SK5	500-006274-0001	M4 screw Spade Terminal - Molex BB-124-08 (19141-0058)

Accessories for SK2:

1. Order kit part number 73-788-001 for control connector interface with .3m wires attached

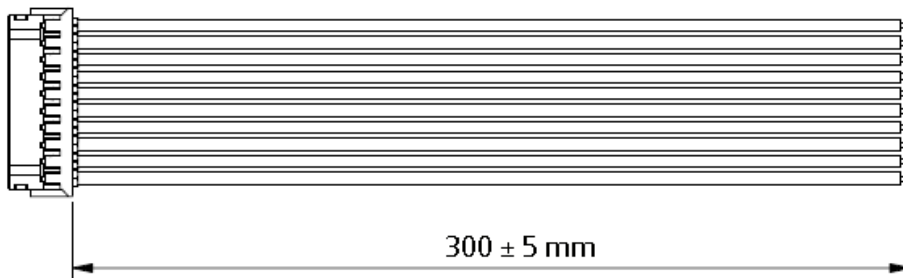

2. Order kit part number 73-788-002 for control connector interface with unloaded housing and 20 pins

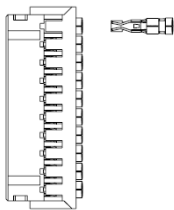

MECHANICAL SPECIFICATIONS

LED Indicator Definitions

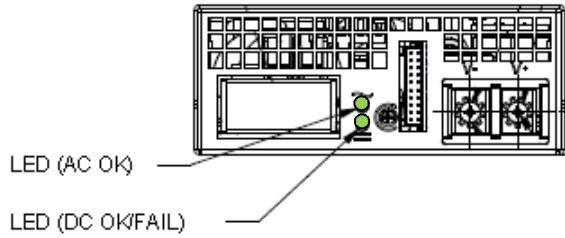

Two user-friendly LEDs for status and diagnostics show status of input power, output power and alarm condition valuable troubleshooting aid to reduce system downtime.

Conditions	LED Status	
	ACOK LED	DCOK/FAIL LED
AC present / Output On	Green	Green
No AC power to PSU	OFF	OFF
Standby mode/main output off	Green	OFF
Power supply failure	Green	OFF

MECHANICAL SPECIFICATIONS

Weight

The LCM300 series weight is 1.76lbs (0.8kg) maximum.

ENVIRONMENTAL SPECIFICATIONS

EMC Immunity

The LCM300 series are designed to meet the following EMC immunity specifications

Table 6. Environmental Specifications	
Document	Description
EN55022	Conducted and radiated EMI limits
EN61000-3-2	EMC limits for Harmonic
EN61000-3-3	Voltage Fluctuations
EN61000-4-2	Electromagnetic Compatibility (EMC) - Testing and measurement techniques - Electrostatic Discharge Immunity test. +/-15KV air, +/-8KV contact discharge
EN61000-4-3	Electromagnetic Compatibility (EMC) - Testing and measurement techniques - Radiated, Radio-frequency, Electromagnetic Field Immunity test. 80MHz – 2.7GHz,10V/m, 80%, AM, 1KHz sine wave
EN61000-4-4	Electromagnetic Compatibility (EMC) - Testing and measurement techniques - Electrical Fast Transient / Burst Immunity test. +/-2KV for AC power port
EN61000-4-5	Electromagnetic Compatibility (EMC) - Testing and measurement techniques - Surge test. 2KV common mode and 1KV differential mode for AC ports
EN61000-4-6	Electromagnetic Compatibility (EMC) - Testing and measurement techniques - Radio Frequency Common Mode
EN61000-4-8	Electromagnetic Compatibility (EMC) - Testing and measurement techniques - Power Freq Magnetic
EN61000-4-11	Electromagnetic Compatibility (EMC) - Testing and measurement techniques - Voltage Dips and Interruptions. 30% reduction for 500mS- Criteria B>95% reduction for 10mS, Criteria A, >95% reduction for 5000mS, Criteria C
EN55024: 1998	Information Technology Equipment - Immunity Characteristics, Limits and Method of Measurement

ENVIRONMENTAL SPECIFICATIONS

Safety Certifications

The LCM300 series are intended for inclusion in other equipment and the installer must ensure that it is in compliance with all the requirements of the end application. This product is only for inclusion by professional installers within other equipment and must not be operated as a stand alone product.

Table 7. Safety Certifications for LCM600 Series Power Supply System		
Standard	File#	Description
UL 62368-1 2 nd Edition	E186249-A267-UL-X9	US Requirements
CSA 22.2 No. 60950-1		Canada Requirements
EN62368-1	E186249-A6001-CB-1	European Requirements
UL60601	E182560-A42-UL	Medical Electrical Equipment
China CCC Approval	2013010907615591	China Requirements
CB Certificate and Report	DK-70362-UL	(All Cenelec Countries)
UKCA Mark		UK Requirements

ENVIRONMENTAL SPECIFICATIONS

EMI Emissions

The LCM300 series has been designed to comply with the Class B limits of EMI requirements of EN55022 (FCC Part 15) and CISPR 22 (EN55022) for emissions and relevant sections of EN61000 (IEC 61000) for immunity. The unit is enclosed inside a metal box, tested at 300W using resistive load with cooling fan.

Conducted Emissions

The applicable standard for conducted emissions is EN55022 (FCC Part 15). Conducted noise can appear as both differential mode and common mode noise currents. Differential mode noise is measured between the two input lines, with the major components occurring at the supply fundamental switching frequency and its harmonics. Common mode noise, a contributor to both radiated emissions and input conducted emissions, is measured between the input lines and system ground and can be broadband in nature.

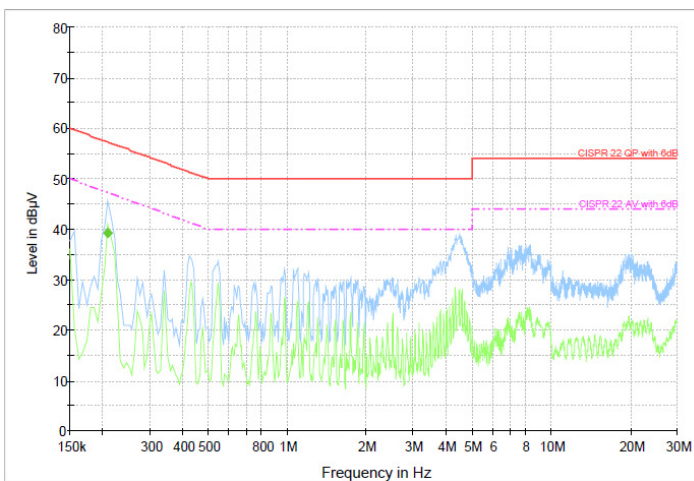

The LCM300 series power supplies have internal EMI ensure the converters' conducted EMI levels comply with EN55022 (FCC Part 15) Class B and EN55022 (CISPR22) Class B limits. The EMI measurements are performed with resistive loads at maximum rated loading.

Sample of EN55022 Conducted EMI Measurement at 100Vac input

Note: Red Line refers to Artesyn Quasi Peak margin, which is 6dB below the CISPR international limit. Pink Line refers to the Emerson Average margin which is 6dB below the CISPR international limit.

Parameter	Model	Symbol	Min	Typ	Max	Unit
FCC Part 15, class B	All	Margin	-	-	6	dB
CISPR 22 (EN55022) class B	All	Margin	-	-	6	dB

Radiated Emissions

Unlike conducted EMI, radiated EMI performance in a system environment may differ drastically from that in a stand-alone power supply. The shielding effect provided by the system enclosure may bring the EMI level from Class A to Class B. It is thus recommended that radiated EMI be evaluated in a system environment. The applicable standard is EN55022 Class A (FCC Part 15). Testing ac-dc convertors as a stand-alone component to the exact requirements of EN55022 can be difficult, because the standard calls for 1m leads to be attached to the input and outputs and aligned such as to maximize the disturbance. In such a set-up, it is possible to form a perfect dipole antenna that very few ac-dc convertors could pass. However, the standard also states that 'an attempt should be made to maximize the disturbance consistent with the typical application by varying the configuration of the test sample.

ENVIRONMENTAL SPECIFICATIONS

Operating Temperature

The LCM300 series maximum output power (300W) can be loaded up to an ambient temperature of +50 °C. Only 50% (150W) of the maximum output power can be loaded at ambient temp of +70 °C. Linear derating to 50% nominal output power starts from +50 °C to 70 °C. The elapsed time between the application of input power and the attainment steady state values requires 5 minutes warm up for -20 °C to -40 °C operation.

Output power vs operating temperature

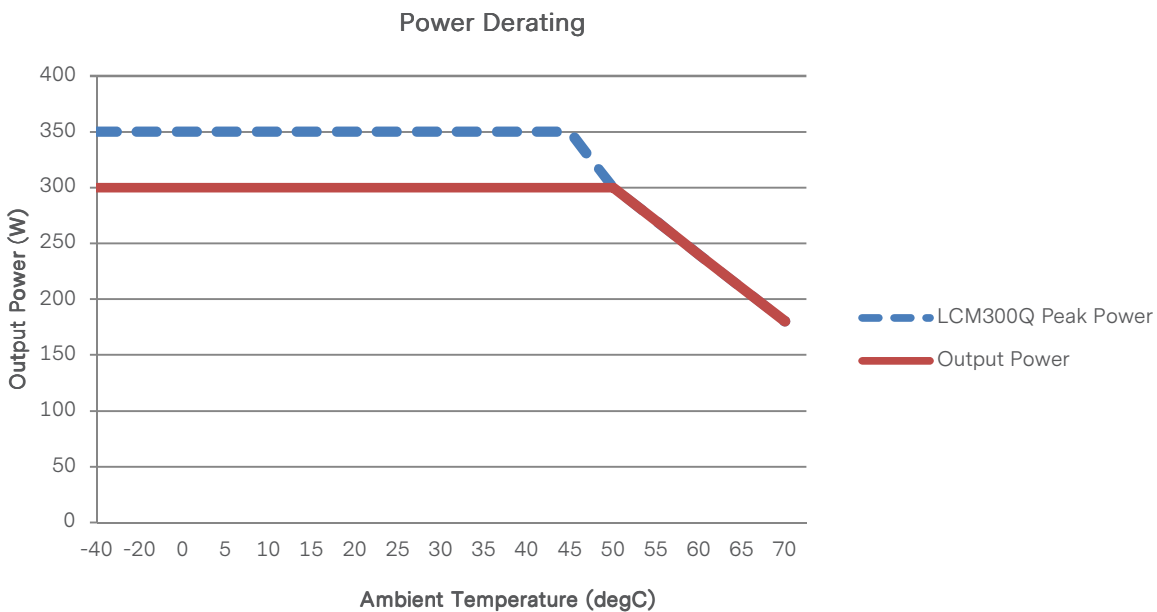

Forced Air Cooling

The LCM300 series power supplies included internal cooling fans as part of the power supply assembly to provide forced air-cooling to maintain and control temperature of devices and ambient temperature in the power supply to appropriate levels. The standard direction of airflow is from the fan side to the AC connector end of the power supply. The cooling fan is a variable speed fan. Fan is smart based on internal temperature. Fan noise less than 45 dBA with 80% load @ 30 °C.

ENVIRONMENTAL SPECIFICATIONS

Storage and Shipping Temperature

The LCM300 series power supplies can be stored or shipped at temperatures between -40°C to $+85^{\circ}\text{C}$ and relative humidity from 20% to 90% non-condensing.

Altitude

The LCM300 series are operate within specifications at altitudes up to 10,000 feet above sea level. The power supply will not be damaged when stored at altitudes of up to 30,000 feet above sea level.

Humidity

The LCM300 series are operate within specifications when subjected to a relative humidity from 20% to 90% non-condensing. The LCM300 series can be stored in a relative humidity from 10% to 95% non-condensing.

Vibration

The LCM300 series will pass the following vibration specifications:

Non-Operating Random Vibration

Acceleration	1.87	1.87	gRMS
Frequency Range	10-500	10-500	Hz
Duration	30	30	Mins
Direction	3 mutually perpendicular axis		
PSD Profile	FREQ (Hz)	SLOPE (db/oct)	PSD (g^2/Hz)
	10-190	/	0.009
	190-210	-2.66	0.009
	210-500	/	0.004

Operating Random Vibration

Acceleration	0.153		gRMS
Frequency Range	5-100		Hz
Duration	30		Mins
Direction	3 mutually perpendicular axis		
PSD Profile	FREQ (Hz)	SLOPE (db/oct)	PSD (g^2/Hz)
	5-10	11	0.00003
	10-50	/	0.004
	50-100	-10	0.00003

ENVIRONMENTAL SPECIFICATIONS

Shock

The LCM300 series power supply will pass the following shock specifications:

Non-Operating Half-Sine Shock

Acceleration	30	G
Duration	18	mSec
Pulse	Half-Sine	
Number of Shock	3 shock on each of 6 faces	

Operating Half-Sine Shock

Acceleration	4	G
Duration	22	mSec
Pulse	Half-Sine	
Number of Shock	3 shocks in each of 6 faces	

POWER AND CONTROL SIGNAL DESCRIPTIONS

AC Input Connector

This connector supplies the AC Mains to the LCM300 series.

- L – L1
- N – L2
- ⊕ – Earth Ground

Output Connectors- SK4&SK5

These pins provide the main output for the LCM300 series. The + Main Output (V_O) and the Main Output Return pins are the positive and negative rails, respectively, of the V_O main output of the LCM300 power supply. The Main Output (V_O) is electrically isolated from the power supply chassis.

- SK4 – + Main Output (V_O)
- SK5 – Main Output Return

Control Signals - SK2

The LCM300 series SK2 contains 20 pins control signal header providing analogy control interface, standby power and i^2C interface.

A0, A1, A2 - (Pin 6, Pin3, Pin1)

Please refer to “Communication Bus Descriptions” section.

-VPROG, +VPROG - (Pin2, Pin8)

Positive and return connection of external supply for Margin Programming. The power supplies have a “margin” pin which will accept a 1-6Vdc signal referenced to a floating return that will program the output the entire adjustment range. -VPROG pin need to connect the main output/standby GND. Applying voltage greater than 6V may result to damage of PSU internal circuit.

-Vsense, +Vsense - (Pin 4, Pin10)

This remote sense circuit is designed to compensate for a power path drop around the entire loop of 0.5 volt. These pins should be connected as close to the loading as possible, If left open, the power supply will regulate the voltage at its output terminals but the voltage level at the load may go lower than the guaranteed spec.

ISHARE - (Pin 5)

The main output have active load sharing. The output share within 10% at full load. All current sharing functions are implemented internal to the power supply by making use of the ISHARE signal. The system connects the ISHARE lines between the power supplies. The supplies are able to load share with up to 10 power supplies in parallel. The I^2C Line should be connected separately when the number of units in parallel is more than 8.

SDA1, SCL1, GND - (Pin 7, Pin9, Pin17)

Please refer to “Communication Bus Descriptions” section.

5VSB, GND - (Pin11, Pin12, Pin13)

The LCM300 series power supply provides a regulated 5 volt 2 amp auxiliary output voltage to power critical circuitry that must remain active regardless of the on/off status of the power supply’s main output. The standby voltage is available whenever a valid AC input voltage is applied to the unit.

POWER AND CONTROL SIGNAL DESCRIPTIONS

G_DCOK_C, G_DCOK_E - (Pin14, Pin16)

G_DCOK_C is a power good signal and is pulled Low by the power supply to indicate that both the outputs are above the regulation limits of the power supply. When any output voltage falls below regulation limits or when AC power has been removed for a time sufficiently long so that power supply operation is no longer guaranteed, G_DCOK_C is de-asserted to a High state. Connect 4.7K resistor on G_DCOK_C to PSU's standby.

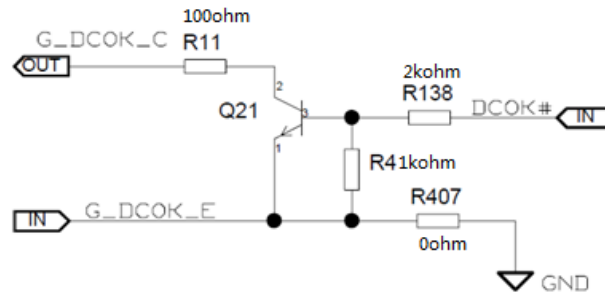

GPIOA6 - (Pin15)

EEPROM Write Protect

G_ACOK_C, G_ACOK_E - (Pin18, Pin20)

G-ACOK_C signal is used to indicate presence of AC input to the power supply. A logic “Low” level on this signal will indicate AC input to the power supply is present. A Logic “High” on this signal will indicate a loss of AC input to the power supply. Connect 4.7K resistor on G_ACOK_C to external standby.

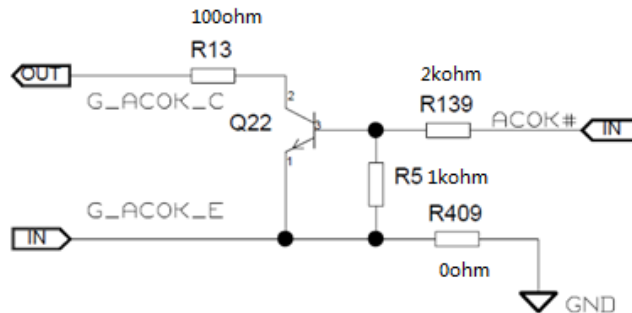

INH_EN - (Pin19)

This signal is required to remotely turn on/off the power supply. When INH_EN is shorted to secondary common, the PSU main output shall turn OFF, otherwise the main output is ON.

COMMUNICATION BUS DESCRIPTIONS

I²C Bus Signals

The LCM300 series contains enhanced monitor and control functions implemented via the I²C bus. The LCM300 series I²C functionality (PMBus™ and FRU data) can be accessed via the output connector control signals. The communication bus is powered either by the internal 3.3V supply or from an external power source connected to the Standby Output (ie: accessing an unpowered power supply as long as the Standby Output of another power supply connected in parallel is on).

If units are connected in parallel or in redundant mode, the Standby Outputs must be connected together in the system. Otherwise, the I²C bus will not work properly when a unit is inserted into the system without the AC source connected.

Note: PMBus™ functionality can be accessed only when the PSU is powered-up. Guaranteed communication I²C speed is 100KHz.

SDA1, SCL1 (I²C Data and Clock Signals) - (pin7, pin 9)

I²C serial data and clock bus - these pins are internally pulled up to internal 3.3V supply with a 4.7K resistor. Recommended external 2.2K ohm pull up on SCL, SDA line on system side to meet I²C rise / fall time specs.

A0, A1, A2 (I²C Address BIT 0, BIT1, BIT2 Signals) - (pin6, pin3, pin1)

These three input pins are the address lines A0, A1 and A2 to indicate the slot position the power supply occupies in the power bay and define the power supply addresses for FRU data and PMBus™ data communication. This allows the system to assign different addresses for each power supply. During I²C communication between system and power supplies, the system is the master and power supplies is slave. They are internally pulled up to internal 5V supply with a 2K resistor and voltage limited to 2.7V with zener diodes.

I²C Bus Communication Interval

The interval between two consecutive I²C communications to the power supply should be at least 50ms to ensure proper monitoring functionality.

I²C Bus Signal Integrity

The noise on the I²C bus (SDA, SCL lines) due to the power supply is less than 500mV peak-to-peak. This noise measurement should be made with an oscilloscope bandwidth limited to 100MHz. Measurements should be made at the power supply output connector with 4.7K ohm resistors pulled up to StandBy Output and 20pf ceramic capacitors to StandBy Output Return.

The noise on the address lines A0 and A1 is less than 100mV peak-to-peak. This noise measurement should be made at the power supply output connector.

COMMUNICATION BUS DESCRIPTIONS

I²C Bus Internal Implementation, Pull-ups and Bus Capacitances

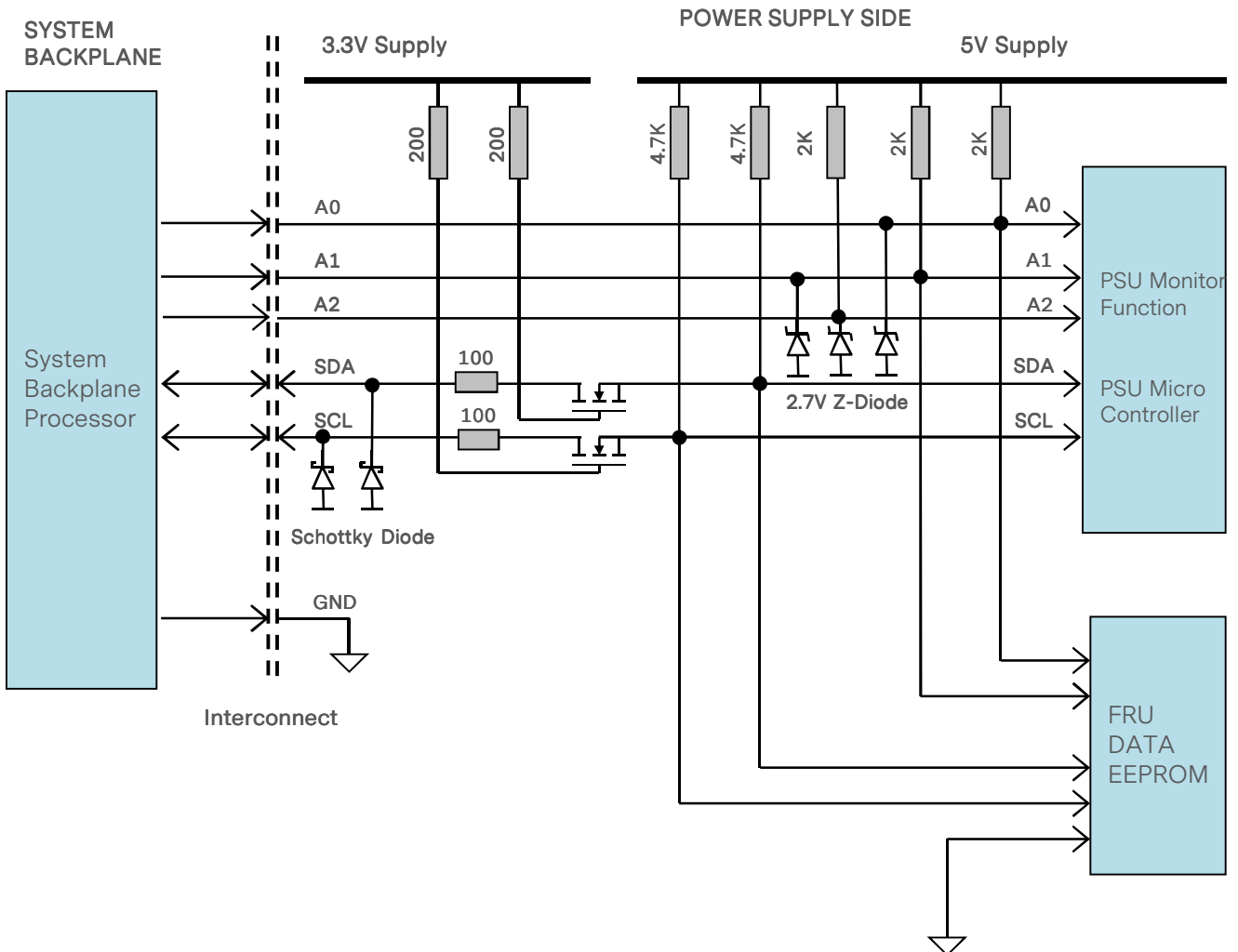

I²C Bus - Recommended external pull-ups

Electrical and interface specifications of I²C signals (referenced to standby output return pin, unless otherwise indicated):

Parameter	Condition	Symbol	Min	Type	Max	Unit
SDA, SCL internal pull-up resistor		R_{int}	-	4.7	-	Kohm
SDA, SCL internal bus capacitance		C_{int}	-	0	-	pF
Recommended external pull-up resistor	1 to 10 PSU	R_{ext}	-	2.2	-	Kohm

COMMUNICATION BUS DESCRIPTIONS

Logic Levels

LCM300 series power supply I²C communication bus will respond to logic levels as per below:

Logic High: 5.1V nominal (Spec is 2.1V to 5.5V)**

Logic Low: 500mV nominal (Spec is 800mV max)**

**Note: Artesyn 73-769-001 I²C adapter was used.

Timings

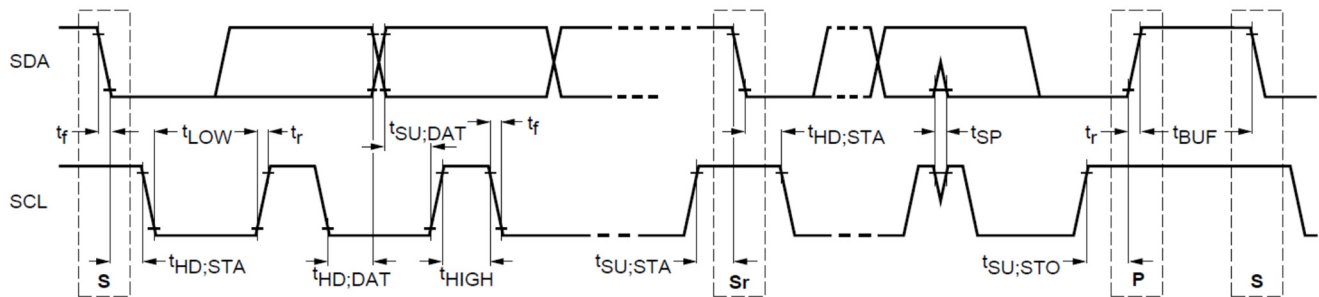

Parameter	Symbol	Standard-Mode Specs		Actual Measured		Unit
		Min	Max			
SCL clock frequency	f _{SCL}	10	100	96		KHz
Hold time (repeated) START condition	t _{HD;STA}	4.0	-	4.6		uS
LOW period of SCL clock	t _{LOW}	4.7	-	4.7		uS
HIGH period of SCL clock	t _{HIGH}	4.0	-	4.7		uS
Setup time for repeated START condition	t _{SU;STA}	4.7	-	4.9		uS
Data hold time	t _{HD;DAT}	0	3.45	0.8		uS
Data setup time	t _{SU;DAT}	250	-	3850		nS
Rise time	t _r	-	600	SCL =900	SDA =925	nS
Fall time	t _f	-	300	SCL =285	SDA =288	nS
Setup time for STOP condition	t _{SU;STO}	4.0	-	6		uS
Bus free time between a STOP and START condition	t _{BUF}	4.7	-	65***		uS

***Note: Artesyn 73-769-001 I²C adapter (USB-to-I2C) and Universal PMBus™ GUI software was used.

COMMUNICATION BUS DESCRIPTIONS

Device Addressing

The LCM300 series will respond to supported commands on the I²C bus that are addressed according to pins A0, A1 and A2 of output connector.

Address pins are held HIGH by default via pulled up to internal 5V supply with a 2K resistor. To set the address as “0”, the corresponding address line should be pulled down to logic ground level. Below tables show the address of the power supply with A0, A1 and A2 pins set to either “0” or “1”:

PSU Slot	Slot ID Bits			PMBus™ Address
	A2	A1	A0	
1	0	0	0	B0
2	0	0	1	B2
3	0	1	0	B4
4	0	1	1	B6
5	1	0	0	B8
6	1	0	1	BA
7	1	1	0	BC
8	1	1	1	BE*

* Default PMBus™ address is BE

COMMUNICATION BUS DESCRIPTIONS

I²C Synchronization

The LCM300 series power supply might apply clock stretching. An addressed slave power supply may hold the clock line (SCL) low after receiving (or sending) a byte, indicating that it is not yet ready to process more data. The system master that is communicating with the power supply will attempt to raise the clock to transfer the next bit, but must verify that the clock line was actually raised. If the power supply is clock stretching, the clock line will still be low (because the connections are open-drain).

The maximum time out condition for clock stretching for LCM300 series power supply is 100 msec.

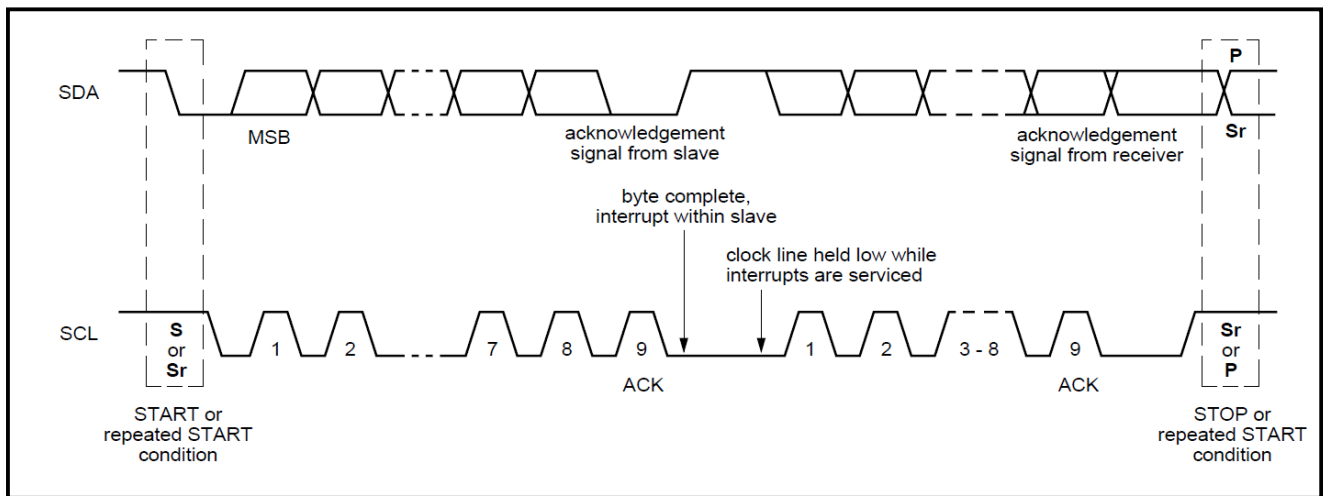

PMBUS™ SPECIFICATIONS

The LCM300 series is compliant with the industry standard PMBus™ protocol for monitoring and control of the power supply via the I²C interface port.

LCM300 Series PMBus™ General Instructions

Equipment Setup

The following is typical I²C communication setup:

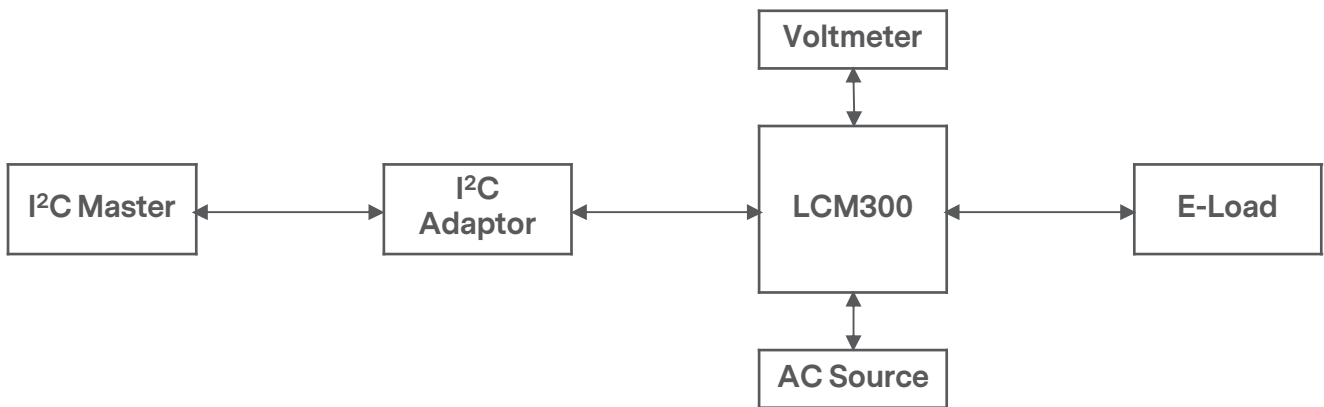

PMBus™ Writing Instructions

When writing to any PMBus™ R/W registers, ALWAYS do the following:

Disable Write Protect (command 10h) by writing any of the following accordingly:

Levels: 00h - Enable writing to all writeable commands

20h - Disables write except 10h, 01h, 00h, 02h and 21h commands

40h - Disables write except 10h, 01h, and 00h commands

80h - Disable write except 0x00h

To save changes on the USER PMBus™ Table:

Use send byte command: 15h STORE_USER_ALL

Wait for 5 seconds, turn-off the PSU, wait for another 5 seconds before turning it on.

PMBUS™ SPECIFICATIONS

The LCM300L-T-4 Supported PMBus™ Command List:

Command Code	Command Name	Default Value	Access Type	Data Bytes	Data Format	Description
00h	PAGE	00	R	1	Bitmapped	
01h	OPERATION	80	R/W	1	Bitmapped	Used to Turn the unit ON/OFF in conjunction with the input CONTROL pin. 80h-turn on 40h-turn off
02h	ON_OFF_CONFIG	1E	R		Bitmapped	Configures the combination of CONTROL pin and serial communication commands needed to turn the Unit ON/OFF.
03h	CLEAR_FAULTS	-	S	0	-	
10h	WRITE_PROTECT	80	R/W	1	Bitmapped	Used to Control Writing to the PMBus Device 80h - Disables write except 10h 40h - Disables write except 10h, 01h, 00h 20h - Disables write except 10h,01h,00h,02h and 21h commands 00 - Enables write to all writeable commands.
15h	STORE_USER_ALL	-	S	0	-	
19h	CAPABILITY	90	R	1	Bitmapped	Provides a way for the hosts system to determine some key capabilities of a PMBus device.
1Ah	QUERY	BC -	BW-BR-PC	1/1	Bitmapped	
20h	VOUT_MODE	17	R	1	Linear	Specifies the mode and parameters of output voltage related Data Formats
21h	VOUT_COMMAND	12.158	R	2	Linear	Set output voltage at 12V. Valid Range:9.6-14.4V
24h	VOUT_MAX	14.398	R	2	Linear	Sets the max adjustable output voltage limit.
30h	COEFFICIENTS	-	BW	2/5	Raw Hex	m = 1, b = 0, R = 0
35h	VIN_ON	82.5	R	2	Linear	Sets the value of input, in volts, at which the unit should start. AC GOOD 82.5 Vac
36h	VIN_OFF	74.5	R	2	Linear	Sets the value of input, in volts, at which the unit should stop power conversion. AC BAD 74.5 Vac
3Ah	FAN_CONFIG_1_2	90	R	1	Bitmapped	Read only to reflect setting of Fans
3Bh	FAN_COMMAND_1	0	R/W	2	Linear	Adjusts the operation of the Fans. The device may override the command, if it requires higher value, to maintain proper device temperature. Duty cycle Control – Commands Speeds from 0 to 100%
40h	VOUT_OV_FAULT_LIMIT	15.6	R	2	Linear	135% of VOUT_COMMAND value Writeable in factory configuration mode for testing only, max value is 16.2V

PMBUS™ SPECIFICATIONS

The LCM300L-T-4 Supported PMBus™ Command List:

Command Code	Command Name	Default Value	Access Type	Data Bytes	Data Format	Description
41h	VOUT_OV_FAULT_RESPONSE	80	R	1	Bitmapped	Unit Latches OFF. Resets on PSON or CONTROL pin recycle or AC recycle.
42h	VOUT_OV_WARN_LIMIT	12.398	R	2	Linear	102% of VOUT_COMMAND value Writeable in factory configuration mode for testing only.
43h	VOUT_UV_WARN_LIMIT	11.92	R	2	Linear	98% of VOUT_COMMAND value Writeable in factory configuration mode for testing only.
44h	VOUT_UV_FAULT_LIMIT	10.34	R	2	Linear	85% of VOUT_COMMAND value Writeable in factory configuration mode for testing only. @12V,10.2V
45h	VOUT_UV_FAULT_RESPONSE	80	R	1	Bitmapped	Turn PSU OFF
46h	IOUT_OC_FAULT_LIMIT	28.438	R	2	Linear	Support read only.
47h	IOUT_OC_FAULT_RESPONSE	FA	R	1	Bitmapped	OCP ride through. If OCP persists.
4Ah	IOUT_OC_WARN_LIMIT	25.594	R	2	Linear	Support read only 90% of IOUT_OC_FAULT_LIMIT value
4Fh	OT_FAULT_LIMIT	131	R	2	Linear	Secondary ambient temperature Fault threshold, in degree C.
50h	OT_FAULT_RESPONSE	78	R	1	Bitmapped	Turn PSU OFF and will retry indefinitely. Supported enable/disable of protection and recoverability.
51h	OT_WARN_LIMIT	100	R	2	Linear	Secondary ambient temperature warning threshold
55h	VIN_OV_FAULT_LIMIT	290	R	2	Linear	Sets input over-voltage threshold. (270Vac) Valid Range: 264 to 300 Vac
56h	VIN_OV_FAULT_RESPONSE	F8	R	1	Bitmapped	
59h	VIN_UV_FAULT_LIMIT	80	R	1	Linear	Default: 80 Vac Valid Rang: 70 to 90 Vac
5Ah	VIN_UV_FAULT_RESPONSE	F8	R	1	Bitmapped	
5Eh	POWER_GOOD_ON	11.92	R	2	Linear	98% of VOUT_COMMAND value
5Fh	POWER_GOOD_OFF	11.67	R	2	Linear	98% of VOUT_COMMAND value
60h	TON_DELAY	0	R	2	Linear	Sets the time (sec), from start condition (Power ON) until the output starts to rise.
61h	TON_RISE	33	R	2	Linear	Sets the time (ms), for the output rises from 0 to regulation. (33ms)
64h	TOFF_DELAY	3.801	R	2	Linear	Sets the time (ms), from a stop condition (Power OFF) until the output starts to drop (converter OFF).(2.8ms)
6Ah	POUT_OP_WARN_LIMIT	356.5	R	2	Linear	Vout_Cmd*Iout_OCP_level*1.03

PMBUS™ SPECIFICATIONS

The LCM300L-T-4 Supported PMBus™ Command List:

Command Code	Command Name	Default Value	Access Type	Data Bytes	Data Format	Description
78h	STATUS_BYTE	00	R	1	Bitmapped	Returns the summary of critical faults
	b7 – BUSY					A fault was declared because the device was busy and unable to respond.
	b6 – OFF					Unit is OFF
	b5 – VOUT_OV					Output over-voltage fault has occurred
	b4 – IOUT_OC					Output over-current fault has occurred
	b3 – VIN_UV					An input under-voltage fault has occurred
	b2 – TEMPERATURE					A temperature fault or warning has occurred
	b1 – CML					A communication, memory or logic fault has occurred
	b0 – NONE OF THE ABOVE					A Fault Warning not listed in bits[7:1] has occurred
79h	STATUS_WORD	0000	R	2	Bitmapped	Summary of units Fault and warning status.
	b15 – VOUT					An output voltage fault or warning has occurred
	b14 – IOUT/POUT					An Output current or power fault or warning has occurred
	b13 – INPUT					An input voltage, current or power fault or warning as occurred
	b12 – MFR					A manufacturer specific fault or warning has occurred.
	b11 – POWER_GOOD#					The POWER_GOOD signal is de-asserted
	b10 – FANS					A fan or airflow fault or warning has occurred.
	b9 – OTHER					A bit in STATUS_OTHER is set
	b8 – UNKNOWN					A fault type not given in bits [15:1] of the STATUS_WORD has been detected
	b7 – BUSY					A fault was declared because the device was busy and unable to respond
	b6 – OFF					Unit is OFF
	b5 – VOUT_OV					Output over-voltage fault has occurred
	b4 – IOUT_OC					Output over-current fault has occurred
	b3 – VIN_UV					An input under-voltage fault has occurred
	b2 – TEMPERATURE					A temperature fault or warning has occurred
	b1 – CML					A communication, memory or logic fault has occurred.
	b0 – NONE_OF_THE_ABOVE					A fault or warning not listed in bits[7:1] of this byte has occurred.

PMBUS™ SPECIFICATIONS

The LCM300L-T-4 Supported PMBus™ Command List:

Command Code	Command Name	Default Value	Access Type	Data Bytes	Data Format	Description
7Ah	STATUS_VOUT	00	R	1	Bitmapped	Output voltage related faults and warnings
	b7					VOUT Over-voltage Fault
	b6					VOUT Over-voltage warning
	b5					VOUT Under-voltage Warning
	b4					VOUT Under-voltage Fault
	b3					Not supported
	b2					Not supported
	b1					Not supported
7Bh	STATUS_IOUT	00	R	1	Bitmapped	Output Current related faults and warnings
	b7					IOUT Over current Fault
	b6					IOUT Over current And Low Voltage shutdown Fault
	b5					VOUT Under-voltage Warning
	b4					VOUT Under-voltage Fault
	b3					VOUT_MAX Warning, an attempt has been made to set output to a value higher than the highest permissible voltage.
	b2					TON_MAX_FAULT
	b1					TOFF_MAX Warning
7Ch	STATUS_INPUT	-	R	1	Bitmapped	
7Dh	STATUS_TEMPERATURE	00	R	1	Bitmapped	Temperature related faults and warnings
	b7					Overtemperature Fault
	b6					Overtemperature Warning
	b5					Undertemperature Warning
	b4					Undertemperature Fault
b3:0					Reserved	
7Eh	STATUS_CML	00	R	1	Bitmapped	Communications, Logic and Memory
80h	STATUS_MFR_SPECIFIC	00	R	1	Bitmapped	Manufacturer Status codes
81h	STATUS_FANS_1_2	00	R	1	Bitmapped	
87h	READ_EOUT	-	BR	6	Linear	Returns the accumulated output power over time
8Bh	READ_VOUT	-	R	2	Linear	Returns the actual, measured voltage in Volts.
8Ch	READ_IOUT	-	R	2	Linear	Returns the output current in amperes.
8Dh	READ_TEMPERATURE_1	-	R	2	Linear	PSU's inter hot spot temperature typically that of the main output rail heat sink. Format is Linear-11

PMBUS™ SPECIFICATIONS

The LCM300L-T-4 Supported PMBus™ Command List:

Command Code	Command Name	Default Value	Access Type	Data Bytes	Data Format	Description
90h	READ_FAN_SPEED_1	-	R	2	Linear	Speed of Fan
96h	READ_POUT		R	2	Linear	Returns the output power, in Watts.
98h	PMBUS_REVISION	-	R	1	Linear	Reads the PMBus revision number
99h	MFR_ID	"Artesyn"	BR	7	ASCII	Abbrev or symbol of manufacturers name.
9Ah	MFR_MODEL	"LCM300L-T-4"	BR	11	ASCII	Manufacturers Model number
9Bh	MFR_REVISION	30,30 - 00	BR/W	2	ASCII	Manufacturers, revision number
9Ch	MFR_LOCATION	"Philippines "	BR/W	11	ASCII	Manufacturers facility
9Dh	MFR_DATE	"YYWW"	BR/W	4	ASCII	Manufacture Date, ASCII format structure : YYMMDD
9Eh	MFR_SERIAL	-	BR/W	13	ASCII	
A0h	MFR_VIN_MIN	90	R	2	Linear	Minimum Input Voltage (90Vac)
A1h	MFR_VIN_MAX	264	R	2	Linear	Maximum Input Voltage (264Vac)
A2h	MFR_IIN_MAX	5	R	2	Linear	Maximum Input Current (5A)
A3h	MFR_PIN_MAX	411.5	R	2	Linear	Default:411.5 W
A4h	MFR_VOUT_MIN	9.6	R	2	Linear	Minimum Output Voltage Regulation Window. (12V)
A5h	MFR_VOUT_MAX	14.398	R	2	Linear	Maximum Output Voltage. Regulation Window (19.5V)
A6h	MFR_IOUT_MAX	29.188	R	2	Linear	Maximum Output Current (23A)
A7h	MFR_POUT_MAX	310	R	2	Linear	Maximum Output Power
A8h	MFR_TAMBIENT_MAX	70	R	2	Linear	Maximum Operating Ambient Temperature (Secondary Ambient) (70 degC)
A9h	MFR_TAMBIENT_MIN	-40	R	2	Linear	Minimum Operating Ambient Temperature (Secondary Ambient) (-40 degC)
AAh	MFR_EFFICIENCY_LL	100,300,85,300,85,300,85	BR	14	Linear	Default:100,300,85,300,85,300,85
ABh	MFR_EFFICIENCY_HL	230,300,89,300,89,300,89	BR	14	Linear	Default:230,300,89,300,89,300,89
B0h	USER_DATA_B0	FF-y	BR/BW		Hex	Can not inter write value by keyboard)
E0h	USER_DATA_00	-	BR	8	ASCII	
E1h	FW_SEC_VERSION	30,31,2E,30,39,2E,30,30-01.09.00	R	8	ASCII	
F1h	ISP_UNLOCK_CODE	0,0,0,0 -	BR/W	4	ASCII	MAP Mode only
F2h	ISP_CTRL_CMD	FF	W	1	Bitmapped	MAP and ISP Mode
F3h	ISP_STATUS_BYTE	00	R	1	Bitmapped	MAP and ISP Mode
F5h	ISP_FLASH_DATA	FF-y	BR/W	16	Direct	ISP Mode only

PMBUS™ SPECIFICATIONS

The LCM300N-T-4 Supported PMBus™ Command List:

Command Code	Command Name	Default Value	Access Type	Data Bytes	Data Format	Description
00h	PAGE	00h	R	1	Bitmapped	
01h	OPERATION	80h	R/W	1	Bitmapped	Used to Turn the unit ON/OFF in conjunction with the input CONTROL pin. 80h-turn on 40h-turn off
02h	ON_OFF_CONFIG	1E	R	1	Bitmapped	Configures the combination of CONTROL pin and serial communication commands needed to turn the Unit ON/OFF.
03h	CLEAR_FAULTS	-	S	0	-	
10h	WRITE_PROTECT	80	R/W	1	Bitmapped	Used to Control Writing to the PMBus Device 80h - Disables write except 10h 40h - Disables write except 10h, 01h, 00h 20h - Disables write except 10h,01h,00h,02h and 21h commands 00 - Enables write to all writeable commands.
15h	STORE_USER_ALL	-	S	0	-	
19h	CAPABILITY	90	R	1	Bitmapped	Provides a way for the hosts system to determine some key capabilities of a PMBus device.
1Ah	QUERY	-	BW-BR-PC	1/1	Bitmapped	
20h	VOUT_MODE	17	R	1	Linear	Specifies the mode and parameters of Output Voltage related Data Formats
21h	VOUT_COMMAND	14.949	R	2	Linear	Set output voltage at 15V. Valid Range:12-18V
24h	VOUT_MAX	19.5	R	2	Linear	Sets the max adjustable output voltage limit.
30h	COEFFICIENTS	-	BW-BR-PC	2/5	Raw Hex	m = 1, b = 0, R = 0
35h	VIN_ON	EA94	R	2	Linear	Sets the value of input, in volts, at which the unit should start. AC GOOD 82.5 Vac
36h	VIN_OFF	EA54	R	2	Linear	Sets the value of input, in volts, at which the unit should stop power conversion. AC BAD 74.5 Vac
3Ah	FAN_CONFIG_1_2	90H	R	1	Bitmapped	Read only to reflect setting of Fans
3Bh	FAN_COMMAND_1	0	R/W	2	Linear	Adjusts the operation of the Fans. The device may override the command, if it requires higher value, to maintain proper device temperature. Duty cycle Control - Commands Speeds from 0 to 100%
40h	VOUT_OV_FAULT_LIMIT	20.18	R	2	Linear	135% of VOUT_COMMAND value Writeable in factory configuration mode for testing only max value is 20.25V

PMBUS™ SPECIFICATIONS

The LCM300N-T-4 Supported PMBus™ Command List:

Command Code	Command Name	Default Value	Access Type	Data Bytes	Data Format	Description
41h	VOUT_OV_FAULT_RESPONSE	80	R	1	Bitmapped	Unit Latches OFF. Resets on PSON or CONTROL pin recycle or AC recycle.
42h	VOUT_OV_WARN_LIMIT	15.238	R	2	Linear	102% of VOUT_COMMAND value Writeable in factory configuration mode for testing only.
43h	VOUT_UV_WARN_LIMIT	14.648	R	2	Linear	98% of VOUT_COMMAND value Writeable in factory configuration mode for testing only.
44h	VOUT_UV_FAULT_LIMIT	12.709	R	2	Linear	85% of VOUT_COMMAND value Writeable in factory configuration mode for testing only. @15V,12.75V
45h	VOUT_UV_FAULT_RESPONSE	80	R	1	Bitmapped	Turn PSU OFF
46h	IOOUT_OC_FAULT_LIMIT	23	R	2	Linear	
47h	IOOUT_OC_FAULT_RESPONSE	FA	R	1	Bitmapped	OCP ride through. If OCP persists.
4Ah	IOOUT_OC_WARN_LIMIT	20.688	R	2	Linear	90% of IOOUT_OC_FAULT_LIMIT value
4Fh	OT_FAULT_LIMIT	115	R	2	Linear	Secondary ambient temperature Fault threshold, in degree C.
50h	OT_FAULT_RESPONSE	C0	R	1	Bitmapped	Turn PSU OFF and will retry indefinitely. Supported enable/disable of protection and recoverability.
51h	OT_WARN_LIMIT	110	R	2	Linear	Secondary ambient temperature warning threshold,
55h	VIN_OV_FAULT_LIMIT	290	R	2	Linear	Sets input over-voltage threshold. (270Vac) Valid Range: 264 to 300 Vac
56h	VIN_OV_FAULT_RESPONSE	F8	R	1	Bitmapped	
59h	VIN_UV_FAULT_LIMIT	80	R	1	Linear	Default: 80 Vac Valid Rang: 70 to 90 Vac
5Ah	VIN_UV_FAULT_RESPONSE	F8	R	1	Bitmapped	
5Eh	POWER_GOOD_ON	14.648	R	2	Linear	Support read only 98% of VOUT_COMMAND value
5Fh	POWER_GOOD_OFF	14.35	R	2	Linear	Support read only 98% of VOUT_COMMAND value
60h	TON_DELAY	0	R	2	Linear	Sets the time (sec), from start condition (Power ON) until the output starts to rise.
61h	TON_RISE	33	R	2	Linear	Sets the time (ms), for the output rises from 0 to regulation. (33ms)
64h	TOFF_DELAY	2.801	R	2	Linear	Sets the time (ms), from a stop condition (Power OFF) until the output starts to drop (converter OFF).(2.8ms)
6Ah	POUT_OP_WARN_LIMIT	354.5	R	2	Linear	Vout_Cmd*Iout_OCP_level*1.03

PMBUS™ SPECIFICATIONS

The LCM300N-T-4 Supported PMBus™ Command List:

Command Code	Command Name	Default Value	Access Type	Data Bytes	Data Format	Description
78h	STATUS_BYTE	00	R	1	Bitmapped	Returns the summary of critical faults
	b7 – BUSY					A fault was declared because the device was busy and unable to respond.
	b6 – OFF					Unit is OFF
	b5 – VOUT_OV					Output over-voltage fault has occurred
	b4 – IOUT_OC					Output over-current fault has occurred
	b3 – VIN_UV					An input under-voltage fault has occurred
	b2 – TEMPERATURE					A temperature fault or warning has occurred
	b1 – CML					A communication, memory or logic fault has occurred.
	b0 – NONE OF THE ABOVE					A Fault Warning not listed in bits[7:1] has occurred.
79h	STATUS_WORD	0000	R	2	Bitmapped	Summary of units Fault and warning status.
	b15 – VOUT					An output voltage fault or warning has occurred
	b14 – IOUT/POUT					An Output current or power fault or warning has occurred.
	b13 – INPUT					An input voltage, current or power fault or warning as occurred.
	b12 – MFR					A manufacturer specific fault or warning has occurred.
	b11 – POWER_GOOD#					The POWER_GOOD signal is de-asserted
	b10 – FANS					A fan or airflow fault or warning has occurred.
	b9 – OTHER					A bit in STATUS_OTHER is set.
	b8 – UNKNOWN					A fault type not given in bits [15:1] of the STATUS_WORD has been detected.
	b7 – BUSY					A fault was declared because the device was busy and unable to respond.
	b6 – OFF					Unit is OFF
	b5 – VOUT_OV					Output over-voltage fault has occurred
	b4 – IOUT_OC					Output over-current fault has occurred
	b3 – VIN_UV					An input under-voltage fault has occurred
	b2 – TEMPERATURE					A temperature fault or warning has occurred
	b1 – CML					A communication, memory or logic fault has occurred.
b0 – NONE_OF_THE_ABOVE					A fault or warning not listed in bits[7:1] of this byte has occurred.	

PMBUS™ SPECIFICATIONS

The LCM300N-T-4 Supported PMBus™ Command List:

Command Code	Command Name	Default Value	Access Type	Data Bytes	Data Format	Description
7Ah	STATUS_VOUT	00	R	1	Bitmapped	Output voltage related faults and warnings
	b7					VOUT Over-voltage Fault
	b6					VOUT Over-voltage warning
	b5					VOUT Under-voltage Warning
	b4					VOUT Under-voltage Fault
	b3					Not supported
	b2					Not supported
	b1					Not supported
	b0					Not supported
7Bh	STATUS_IOUT	00	R	1	Bitmapped	Output Current related faults and warnings
	b7					IOUT Over current Fault
	b6					IOUT Over current And Low Voltage shutdown Fault
	b5					VOUT Under-voltage Warning
	b4					VOUT Under-voltage Fault
	b3					VOUT_MAX Warning, an attempt has been made to set output to a value higher than the highest permissible voltage.
	b2					TON_MAX_FAULT
	b1					TOFF_MAX Warning
	b0					reserved
7Ch	STATUS_INPUT	-	R	1	Bitmapped	
7Dh	STATUS_TEMPERATURE	00	R	1	Bitmapped	Temperature related faults and warnings
	b7					Overtemperature Fault
	b6					Overtemperature Warning
	b5					Undertemperature Warning
	b4					Undertemperature Fault
	b3:0					Reserved
7Eh	STATUS_CML	00	R	1	Bitmapped	Communications, Logic and Memory
80h	STATUS_MFR_SPECIFIC	00	R	1	Bitmapped	Manufacturer Status codes
81h	STATUS_FANS_1_2	00	R	1	Bitmapped	
87h	READ_EOUT	-	BR	6	Linear	Returns the accumulated output power over time
8Bh	READ_VOUT	-	R	2	Linear	Returns the actual, measured voltage in Volts.
8Ch	READ_IOUT	-	R	2	Linear	Returns the output current in amperes.
8Dh	READ_TEMPERATURE_1	-	R	2	Linear	PSU's inter hot spot temperature typically that of the main output rail heat sink. Format is Linear-11

PMBUS™ SPECIFICATIONS

The LCM300N-T-4 Supported PMBus™ Command List:

Command Code	Command Name	Default Value	Access Type	Data Bytes	Data Format	Description
90h	READ_FAN_SPEED_1	-	R	2	Linear	Speed of Fan
96h	READ_POUT		R	2	Linear	Returns the output power, in Watts.
98h	PMBUS_REVISION	-	R	1	Linear	Reads the PMBus revision number
99h	MFR_ID	"Artesyn"	R/W	7	ASCII	Abbrev or symbol of manufacturers name.
9Ah	MFR_MODEL	"LCM300N-T-4"	BR	11	ASCII	Manufacturers Model number
9Bh	MFR_REVISION	30,30-00	R/W	2	ASCII	Manufacturers, revision number
9Ch	MFR_LOCATION	"Philippines "	R/W	11	ASCII	Manufacturers facility
9Dh	MFR_SERIAL	"YYWW"	R/W	4	ASCII	Manufacture Date structure : YYMMDD
9Eh	MFR_SERIAL	-	BR/W	13	ASCII	
A0h	MFR_VIN_MIN	90	R	2	Linear	Minimum Input Voltage (90Vac)
A1h	MFR_VIN_MAX	264	R	2	Linear	Maximum Input Voltage (264Vac)
A2h	MFR_IIN_MAX	5	R	2	Linear	Maximum Input Current (5A)
A3h	MFR_PIN_MAX	411.5	R	2	Linear	Default:411.5 W
A4h	MFR_VOUT_MIN	12	R	2	Linear	Minimum Output Voltage Regulation Window. (12V)
A5h	MFR_VOUT_MAX	19.5	R	2	Linear	Maximum Output Voltage. Regulation Window (19.5V)
A6h	MFR_IOUT_MAX	23	R	2	Linear	Maximum Output Current (23A)
A7h	MFR_POUT_MAX	310	R	2	Linear	Maximum Output Power
A8h	MFR_TAMBIENT_MAX	70	R	2	Linear	Maximum Operating Ambient Temperature (Secondary Ambient) (70 degC)
A9h	MFR_TAMBIENT_MIN	-40	R	2	Linear	Minimum Operating Ambient Temperature (Secondary Ambient) (-40 degC)
AAh	MFR_EFFICIENCY_LL	100,300,85,300,85,300,85	BR	14	Linear	Default:100,300,85,300,85,300,85
ABh	MFR_EFFICIENCY_HL	230,300,89,300,89,300,89	BR	14	Linear	Default:230,300,89,300,89,300,89
B0h	USER_DATA_B0	FF-y	BR	Varies	Hex	Can not inter write value by keyboard)
E0h	USER_DATA_00	-	BR	8	ASCII	
E1	FW_SEC_REVISION	-	BR	8	ASCII	
F1h	ISP_UNLOCK_CODE	-	BR/W	4	ASCII	00h,00h,00h,00h
F2h	ISP_CTRL_CMD	-	W	1	Bitmapped	MAP and ISP Mode
F3h	ISP_STATUS_BYTE	-	R	1	Bitmapped	MAP and ISP Mode
F5h	ISP_FLASH_DATA	-	BR/W	16	Direct	ISP Mode only

PMBUS™ SPECIFICATIONS

The LCM300Q-T-4 Supported PMBus™ Command List:

Command Code	Command Name	Default Value	Access Type	Data Bytes	Data Format	Description
00h	PAGE	00	R	1	Bitmapped	
01h	OPERATION	80	R/W	1	Bitmapped	Used to turn the unit ON/OFF in conjunction with the input CONTROL pin. It is also used to set output to upper or lower margin voltages.
02h	ON_OFF_CONFIG	1E	R		Bitmapped	Configures the combination of CONTROL pin and serial communication commands needed to turn the Unit ON/OFF.
03h	CLEAR_FAULTS	-	S	0	-	
10h	WRITE_PROTECT	80	R/W	1	Bitmapped	Used to Control Writing to the PMBus Device 80h - Disables write except 10h 40h - Disables write except 10h, 01h, 00h 20h - Disables write except 10h, 01h, 00h, 02h and 21h commands 00 - Enables write to all writeable commands.
15h	STORE_USER_ALL	-	S	0	-	
19h	CAPABILITY	90	R	1	Bitmapped	Provides a way for the hosts system to determine some key capabilities of a PMBus device.
1Ah	QUERY	-	BW-BR-PC	1/1	Bitmapped	
20h	VOUT_MODE	17	R	1	Linear	Specifies the mode and parameters of Output Voltage related Data Formats
21h	VOUT_COMMAND	2FE6	R	2	Linear	Set output voltage at 24V. Valid range:19.09-33.60V
24h	VOUT_MAX	3999	R	2	Linear	Sets the max adjustable output voltage limit 28.9V
30h	COEFFICIENTS	-	BW-BR-PC	2/5	Raw Hex	m = 1, b = 0, R = 0
35h	VIN_ON	EA94	R	2	Linear	Sets the value of input, in volts, at which the unit should start. AC GOOD 82.5 Vac
36h	VIN_OFF	EA54	R	2	Linear	Sets the value of input, in volts, at which the unit should stop power conversion. AC BAD 74.5 Vac
3Ah	FAN_CONFIG_1_2	90	R	1	Bitmapped	Read only to reflect setting of Fans
3Bh	FAN_COMMAND_1	0	R/W	2	Linear	Adjusts the operation of the Fans. The device may override the command, if it requires higher value, to maintain proper device temperature. Duty cycle Control – Commands Speeds from 0 to 100%
40h	VOUT_OV_FAULT_LIMIT	Varies	R	2	Linear	135% of VOUT_COMMAND value Writeable in factory configuration mode for testing only

PMBUS™ SPECIFICATIONS

The LCM300Q-T-4 Supported PMBus™ Command List:

Command Code	Command Name	Default Value	Access Type	Data Bytes	Data Format	Description
41h	VOUT_OV_FAULT_RESPONSE	80	R	1	Bitmapped	Unit Latches OFF. Resets on PSON or CONTROL pin recycle or AC recycle.
42h	VOUT_OV_WARN_LIMIT	30DC	R	2	Linear	102% of VOUT_COMMAND value Writeable in factory configuration mode for testing only.
43h	VOUT_UV_WARN_LIMIT	2EF5	R	2	Linear	98% of VOUT_COMMAND value Writeable in factory configuration mode for testing only
44h	VOUT_UV_FAULT_LIMIT	28BD	R	2	Linear	85% of VOUT_COMMAND value Writeable in factory configuration mode for testing only
45h	VOUT_UV_FAULT_RESPONSE	80	R	1	Bitmapped	Turn PSU OFF
46h	IOUT_OC_FAULT_LIMIT	D3C1	R	2	Linear	16.68A at VOUT_COMMAND <= 24V Linear decrease, 16.68A at VOUT_COMMAND 24V to 13.97A at 28.9V,
47h	IOUT_OC_FAULT_RESPONSE	BA	R	1	Bitmapped	OCP ride through. If OCP persists. Default: BAh
4Ah	IOUT_OC_WARN_LIMIT	C0	R	2	Linear	Support read only 90% of IOUT_OC_FAULT_LIMIT value @24v,15.012A
4Fh	OT_FAULT_LIMIT	EAA8	R	2	Linear	Secondary ambient temperature Fault threshold, in degree C. (97degC)
50h	OT_FAULT_RESPONSE	C0	R	1	Bitmapped	Turn PSU OFF and will retry indefinitely. Supported enable/disable of protection and recoverability.
51h	OT_WARN_LIMIT	E330	R	2	Linear	Secondary ambient temperature warning threshold.
55h	VIN_OV_FAULT_LIMIT	FA1C	R	2	Linear	Sets input over-voltage threshold. (266Vac) Valid Range: 264 to 300 Vac
56h	VIN_OV_FAULT_RESPONSE	80	R	1	Bitmapped	
59h	VIN_UV_FAULT_LIMIT	EA80	R	2	Linear	Default: 80 Vac Valid Rang: 70 to 90 Vac
5Ah	VIN_UV_FAULT_RESPONSE	C0	R	1	Bitmapped	
5Eh	POWER_GOOD_ON	2EF0	R	2	Linear	98% of VOUT_COMMAND value@24V-23.52V
5Fh	POWER_GOOD_OFF	2EF0	R	2	Linear	96% of VOUT_COMMAND value@24V-23.04V
60h	TON_DELAY	0	R	2	Linear	Sets the time (sec), from start condition (Power ON) until the output starts to rise. (0-32767uS)
61h	TON_RISE	E210	R	2	Linear	Sets the time (ms), for the output rises from 0 to regulation. (33ms)
64h	TOFF_DELAY	C2CD	R	2	Linear	Sets the time (ms), from a stop condition (Power OFF) until the output starts to drop (converter OFF).(2.8ms)
6Ah	POUT_OP_WARN_LIMIT	FB37	R	2	Linear	

PMBUS™ SPECIFICATIONS

The LCM300Q-T-4 Supported PMBus™ Command List:

Command Code	Command Name	Default Value	Access Type	Data Bytes	Data Format	Description
78h	STATUS_BYTE	00	R	1	Bitmapped	Returns the summary of critical faults
	b7 – BUSY					A fault was declared because the device was busy and unable to respond.
	b6 – OFF					Unit is OFF
	b5 – VOUT_OV					Output over-voltage fault has occurred
	b4 – IOUT_OC					Output over-current fault has occurred
	b3 – VIN_UV					An input under-voltage fault has occurred
	b2 – TEMPERATURE					A temperature fault or warning has occurred
	b1 – CML					A communication, memory or logic fault has occurred.
	b0 – NONE OF THE ABOVE					A Fault Warning not listed in bits[7:1] has occurred.
79h	STATUS_WORD	0000	R	2	Bitmapped	Summary of units Fault and warning status.
	b15 – VOUT					An output voltage fault or warning has occurred
	b14 – IOUT/POUT					An Output current or power fault or warning has occurred.
	b13 – INPUT					An input voltage, current or power fault or warning as occurred.
	b12 – MFR					A manufacturer specific fault or warning has occurred.
	b11 – POWER_GOOD#					The POWER_GOOD signal is de-asserted
	b10 – FANS					A fan or airflow fault or warning has occurred.
	b9 – OTHER					A bit in STATUS_OTHER is set.
	b8 – UNKNOWN					A fault type not given in bits [15:1] of the STATUS_WORD has been detected.
	b7 – BUSY					A fault was declared because the device was busy and unable to respond.
	b6 – OFF					Unit is OFF
	b5 – VOUT_OV					Output over-voltage fault has occurred
	b4 – IOUT_OC					Output over-current fault has occurred
	b3 – VIN_UV					An input under-voltage fault has occurred
	b2 – TEMPERATURE					A temperature fault or warning has occurred
	b1 – CML					A communication, memory or logic fault has occurred.
b0 – NONE_OF_THE_ABOVE					A fault or warning not listed in bits[7:1] of this byte has occurred.	

PMBUS™ SPECIFICATIONS

The LCM300Q-T-4 Supported PMBus™ Command List:

Command Code	Command Name	Default Value	Access Type	Data Bytes	Data Format	Description
7Ah	STATUS_VOUT	00	R	1	Bitmapped	Output voltage related faults and warnings
	b7					VOUT Over-voltage Fault
	b6					VOUT Over-voltage warning
	b5					VOUT Under-voltage Warning
	b4					VOUT Under-voltage Fault
	b3					Not supported
	b2					Not supported
	b1					Not supported
7Bh	STATUS_IOUT	00	R	1	Bitmapped	Output Current related faults and warnings
	b7					IOUT Over current Fault
	b6					IOUT Over current And Low Voltage shutdown Fault
	b5					VOUT Under-voltage Warning
	b4					VOUT Under-voltage Fault
	b3					VOUT_MAX Warning, an attempt has been made to set output to a value higher than the highest permissible voltage.
	b2					TON_MAX_FAULT
	b1					TOFF_MAX Warning
	b0					reserved
7Ch	STATUS_INPUT	-	R	1	Bitmapped	
7Dh	STATUS_TEMPERATURE	00	R	1	Bitmapped	Temperature related faults and warnings
	b7					Overtemperature Fault
	b6					Overtemperature Warning
	b5					Undertemperature Warning
	b4					Undertemperature Fault
b3:0					Reserved	
7Eh	STATUS_CML	00	R	1	Bitmapped	Communications, Logic and Memory
80h	STATUS_MFR_SPECIFIC	00	R	1	Bitmapped	Manufacturer Status codes
81h	STATUS_FANS_1_2	-	R	1	Bitmapped	
87h	READ_EOUT	-	BR	6	Linear	Returns the accumulated output power over time
8Bh	READ_VOUT	-	R	2	Linear	Returns the actual, measured voltage in Volts.
8Ch	READ_IOUT	-	R	2	Linear	Returns the output current in amperes.

PMBUS™ SPECIFICATIONS

The LCM300Q-T-4 Supported PMBus™ Command List:

Command Code	Command Name	Default Value	Access Type	Data Bytes	Data Format	Description
8Dh	READ_TEMPERATURE_2	-	R	2	Linear	
90h	READ_FAN_SPEED				Linear	Speed of Fan
96h	READ_POUT	-	R	2	Linear	Returns the output power, in Watts.
98h	PMBUS_REVISION	22	R	1	Linear	Reads the PMBus revision number
99h	MFR_ID	-	BR	7	ASCII	Abbrev or symbol of manufacturers name.
9Ah	MFR_MODEL	"LCM300Q-T-4"	RR	11	ASCII	Manufacturers Model number
9Bh	MFR_REVISION	"0A"	RR/W	2	ASCII	Manufacturers, revision number
9Ch	MFR_LOCATION	"Philippines "	RR/W	11	ASCII	Manufacturers facility
9Dh	MFR_DATE	-	BR/W	4	ASCII	
9Eh	MFR_SERIAL	-	BR/W	13	ASCII	
A0h	MFR_VIN_MIN	EB20	R	2	Linear	Minimum Input Voltage (100Vac)
A1h	MFR_VIN_MAX	F3C0	R	2	Linear	Maximum Input Voltage (240Vac)
A2h	MFR_IIN_MAX	CA80	R	2	Linear	Maximum Input Current (5A)
A3h	MFR_PIN_MAX	-	R	2	Linear	Default: 411.75W
A4h	MFR_VOUT_MIN	2F0A	R	2	Linear	Minimum Output Voltage Regulation Window. (19.2V)
A5h	MFR_VOUT_MAX	30F6	R	2	Linear	Maximum Output Voltage. Regulation Window (28.8V)
A6h	MFR_IOUT_MAX	DB20	R	2	Linear	Maximum Output Current (14.5A)
A7h	MFR_POUT_MAX	FABC	R	2	Linear	Maximum Output Power
A8h	MFR_TAMBIENT_MAX	EA30	R	2	Linear	Maximum Operating Ambient Temperature (Secondary Ambient) (70degC)
A9h	MFR_TAMBIENT_MIN	E580	R	2	Linear	Minimum Operating Ambient Temperature (Secondary Ambient) (-40 degC)
AAh	MFR_EFFICIENCY_LL	100,350,85,350,85,350,85	BR	14	Linear	Default:100,350,85,350,85,350,85
ABh	MFR_EFFICIENCY_HL	230,350,87,350,87,350,87	BR	14	Linear	Default:230,350,87,350,87,350,87
B0h	USER_DATA_00	-	BR/BR	Varies	Hex	
E0h	USER_DATA_00	-	BR	8	ASCII	
E1h	FW_SEC_REVISION	-	BR	8	ASCII	
F1h	ISP_UNLOCK_CODE	-	BR/W	4	ASCII	00h,00h,00h,00h
F2h	ISP_CTRL_CMD		W	1	Bitmapped	MAP and ISP Mode
F3h	ISP_STATUS_BYTE	-	R	1	Bitmapped	MAP and ISP Mode
F5h	ISP_FLASH_DATA	-	BR/W	16	Direct	ISP Mode only

PMBUS™ SPECIFICATIONS

The LCM300U-T-4 Supported PMBus™ Command List:

Command Code	Command Name	Default Value	Access Type	Data Bytes	Data Format	Description
00h	PAGE	00	R	1	Bitmapped	
01h	OPERATION	80	R/W	1	Bitmapped	
02h	ON_OFF_CONFIG	1E	Bitmapped	1	Bitmapped	
03h	CLEAR_FAULTS	-	S	0	-	
10h	WRITE_PROTECT	80	R/W	1	Bitmapped	Used to Control Writing to the PMBus Device 80h - Disables write except 10h 40h - Disables write except 10h, 01h, 00h 20h - Disables write except 10h,01h,00h,02h and 21h commands 00 - Enables write to all writeable commands.
15h	STORE_USER_ALL	-	S	0	-	
19h	CAPABILITY	90	R	1	Bitmapped	Provides a way for the hosts system to determine some key capabilities of a PMBus device
1Ah	QUERY	Varies	BW-BR-PC	1/1	Bitmapped	
20h	VOUT_MODE	17	R	1	Linear	Specifies the mode and parameters of Output Voltage related Data Formats
21h	VOUT_COMMAND	3F9E	R	2	Linear	Set output voltage at 36V. Valid range:28.79-50.41V
24h	VOUT_MAX	5666	R	2	Linear	Sets the max adjustable output voltage limit. 43.2V
30h	COEFFICIENTS	-	BW-BR-PC	2/5	Raw Hex	m = 1, b = 0, R = 0
35h	VIN_ON	EA94	R	2	Linear	Sets the value of input, in volts, at which the unit should start. AC GOOD 82.5 Vac
36h	VIN_OFF	EA54	R	2	Linear	Sets the value of input, in volts, at which the unit should stop power conversion. AC BAD74.5 Vac
3Ah	FAN_CONFIG_1_2	90h	R	1	Bitmapped	Read only to reflect setting of Fans
3Bh	FAN_COMMAND_1	0	R/W	2	Linear	Adjusts the operation of the Fans. The device may override the command, if it requires higher value, to maintain proper device temperature. Duty cycle control – Commands Speeds from 0 to 100%
40h	VOUT_OV_FAULT_LIMIT	Varies	R	2	Linear	135% of VOUT_COMMAND value Writeable in factory configuration mode for testing only
41h	VOUT_OV_FAULT_RESPONSE	80	R	1	Bitmapped	Unit Latches OFF. Resets on PSON or CONTROL pin recycle or AC recycle
42h	VOUT_OV_WARN_LIMIT	Varies	R	2	Linear	102% of VOUT_COMMAND value Writeable in factory configuration mode for testing only@36V,36.72V

PMBUS™ SPECIFICATIONS

The LCM300U-T-4 Supported PMBus™ Command List:

Command Code	Command Name	Default Value	Access Type	Data Bytes	Data Format	Description
43h	VOUT_UV_WARN_LIMIT	Varies	R	2	Linear	98% of VOUT_COMMAND value Writeable in factory configuration mode for testing only@36V,36.60V
44h	VOUT_UV_FAULT_LIMIT	Varies	R	2	Linear	85% of VOUT_COMMAND value Writeable in factory configuration mode for testing only@36V,36.60V
45h	VOUT_UV_FAULT_RESPONSE	80h	R	1	Bitmapped	Turn PSU OFF
46h	IOUT_OC_FAULT_LIMIT	Varies	R	2	Linear	
47h	IOUT_OC_FAULT_RESPONSE	BA	R	1	Bitmapped	OCP ride through. If OCP persists.
4Ah	IOUT_OC_WARN_LIMIT	Varies	R	2	Linear	90% of IOUT_OC_FAULT_LIMIT value @36V,10.035A
4Fh	OT_FAULT_LIMIT	EAA8	R	2	Linear	Default:85degC Valid Range:80-85degC
50h	OT_FAULT_RESPONSE	C0	R	1	Bitmapped	
51h	OT_WARN_LIMIT	EA80	R	2	Linear	Secondary ambient temperature warning threshold.
55h	VIN_OV_FAULT_LIMIT	FA1C	R	2	Linear	Sets input over-voltage threshold. (270Vac) Valid Range: 264 to 300Vac
56h	VIN_OV_FAULT_RESPONSE	80	R	1	Bitmapped	
59h	VIN_UV_FAULT_LIMIT	EA80	R	2	Linear	Default: 80 Vac Valid rang: 70 to 90 Vac
5Ah	VIN_UV_FAULT_RESPONSE	C0	R	1	Bitmapped	
5Eh	POWER_GOOD_ON	Varies	R	2	Linear	98% of VOUT_COMMAND value @36v-35.28V
5Fh	POWER_GOOD_OFF	Varies	R	2	Linear	98% of VOUT_COMMAND value @36v-34.56V
60h	TON_DELAY	0	R	2	Linear	Sets the time (sec), from start condition (Power ON) until the output starts to rise. (0-32767uS)
61h	TON_RISE	E210	R	2	Linear	Sets the time (ms), for the output rises from 0 to regulation. (33ms)
64h	TOFF_DELAY	C2CD	R	2	Linear	Sets the time (ms), from a stop condition (Power OFF) until the output starts to drop (converter OFF)(2.8ms) Valid Range:0-32.7ms
6Ah	POUT_OP_WARN_LIMIT	Varies	R	2	Linear	Vout_Cmd*Iout_OCP_level*1.03

PMBUS™ SPECIFICATIONS

The LCM300U-T-4 Supported PMBus™ Command List:

Command Code	Command Name	Default Value	Access Type	Data Bytes	Data Format	Description
78h	STATUS_BYTE	00	R	1	Bitmapped	Returns the summary of critical faults
	b7 – BUSY					A fault was declared because the device was busy and unable to respond.
	b6 – OFF					Unit is OFF
	b5 – VOUT_OV					Output over-voltage fault has occurred
	b4 – IOUT_OC					Output over-current fault has occurred
	b3 – VIN_UV					An input under-voltage fault has occurred
	b2 – TEMPERATURE					A temperature fault or warning has occurred
	b1 – CML					A communication, memory or logic fault has occurred.
	b0 – NONE OF THE ABOVE					A Fault Warning not listed in bits[7:1] has occurred.
79h	STATUS_WORD	0000	R	2	Bitmapped	Summary of units Fault and warning status.
	b15 – VOUT					An output voltage fault or warning has occurred
	b14 – IOUT/POUT					An Output current or power fault or warning has occurred.
	b13 – INPUT					An input voltage, current or power fault or warning as occurred.
	b12 – MFR					A manufacturer specific fault or warning has occurred.
	b11 – POWER_GOOD#					The POWER_GOOD signal is de-asserted
	b10 – FANS					A fan or airflow fault or warning has occurred.
	b9 – OTHER					A bit in STATUS_OTHER is set.
	b8 – UNKNOWN					A fault type not given in bits [15:1] of the STATUS_WORD has been detected.
	b7 – BUSY					A fault was declared because the device was busy and unable to respond.
	b6 – OFF					Unit is OFF
	b5 – VOUT_OV					Output over-voltage fault has occurred
	b4 – IOUT_OC					Output over-current fault has occurred
	b3 – VIN_UV					An input under-voltage fault has occurred
	b2 – TEMPERATURE					A temperature fault or warning has occurred
	b1 – CML					A communication, memory or logic fault has occurred.
b0 – NONE_OF_THE_ABOVE					A fault or warning not listed in bits[7:1] of this byte has occurred.	

PMBUS™ SPECIFICATIONS

The LCM300U-T-4 Supported PMBus™ Command List:

Command Code	Command Name	Default Value	Access Type	Data Bytes	Data Format	Description
7Ah	STATUS_VOUT	00	R	1	Bitmapped	Output voltage related faults and warnings
	b7					VOUT Over-voltage Fault
	b6					VOUT Over-voltage warning
	b5					VOUT Under-voltage Warning
	b4					VOUT Under-voltage Fault
	b3					Not supported
	b2					Not supported
	b1					Not supported
7Bh	STATUS_IOUT	00	R	1	Bitmapped	Output Current related faults and warnings
	b7					IOUT Over current Fault
	b6					IOUT Over current And Low Voltage shutdown Fault
	b5					VOUT Under-voltage Warning
	b4					VOUT Under-voltage Fault
	b3					VOUT_MAX Warning, an attempt has been made to set output to a value higher than the highest permissible voltage.
	b2					TON_MAX_FAULT
	b1					TOFF_MAX Warning
	b0					reserved
7Ch	STATUS_INPUT	-	R	1	Bitmapped	
7Dh	STATUS_TEMPERATURE	00	R	1	Bitmapped	Temperature related faults and warnings
	b7					Overtemperature Fault
	b6					Overtemperature Warning
	b5					Undertemperature Warning
	b4					Undertemperature Fault
b3:0					reserved	
7Eh	STATUS_CML	00	R	1	Bitmapped	
80h	STATUS_MFR_SPECIFIC	00	R	1	Bitmapped	
81h	STATUS_FANS_1_2	00	R	1	Bitmapped	
87h	READ_EOUT	-	BR	6	Linear	5% accuracy @ > 5% load
8Bh	READ_VOUT	-	R	2	Linear	5% accuracy
8Ch	READ_IOUT	-	R	2	Linear	5% accuracy @ > 40% load
8Dh	READ_TEMPERATURE_2	-	R	2	Linear	5 degC accuracy
90h	READ_FAN SPEED	-	R	2	Linear	500 RPM accuracy

PMBUS™ SPECIFICATIONS

The LCM300U-T-4 Supported PMBus™ Command List:

Command Code	Command Name	Default Value	Access Type	Data Bytes	Data Format	Description
96h	READ_POUT	-	R	2	Linear	5% accuracy @ > 5% load
98h	PMBUS_REVISION	22h	R	1	Linear	Reads the PMBus revision number
99h	MFR_ID	"Artesyn"	BR	7	ASCII	Abbrev or symbol of manufacturers name.
9Ah	MFR_MODEL	"LCM300U-T-4"	BR	11	ASCII	Manufacturers Model number
9Bh	MFR_REVISION	"0A "	BR/W	2	ASCII	Manufacturers, revision number
9Ch	MFR_LOCATION	"Philippines "	BR/W	11	ASCII	Manufacturers facility
9Dh	MFR_DATE	"YYWW"	BR/W	4	ASCII	Manufacture Date, ASCII format structure : YYMMDD
9Eh	MFR_SERIAL	-	BR/W	13	ASCII	
A0h	MFR_VIN_MIN	EAD0	R	2	Linear	Minimum Input Voltage (90Vac)
A1h	MFR_VIN_MAX	FA10	R	2	Linear	Maximum Input Voltage (240Vac)
A2h	MFR_IIN_MAX	CA80	R	2	Linear	Maximum Input Current (5A)
A3h	MFR_PIN_MAX	-	R	2	Linear	Default:411.75 W
A4h	MFR_VOUT_MIN	2666	R	2	Linear	Minimum Output Voltage Regulation Window. (28.8V)
A5h	MFR_VOUT_MAX	3999	R	2	Linear	Maximum Output Voltage. Regulation Window (43.2V)
A6h	MFR_IOUT_MAX	D3A0	R	2	Linear	Maximum Output Current (9.7A)
A7h	MFR_POUT_MAX	FABC	R	2	Linear	Maximum Output Power
A8h	MFR_TAMBIENT_MAX	EA30	R	2	Linear	Maximum Operating Ambient Temperature (Secondary Ambient) (70degC)
A9h	MFR_TAMBIENT_MIN	E580	R	2	Linear	Minimum Operating Ambient Temperature (Secondary Ambient) (-40 degC)
AAh	MFR_EFFICIENCY_LL	100,350,85,350,85,350,85	BR	14	Linear	Default:100,350,85,350,85,350,85
ABh	MFR_EFFICIENCY_HL	230,350,87,350,87,350,87	BR	14	Linear	Default:230,350,87,350,87,350,87
B0h	USER_DATA_00	-	BR/BW		ASCII	
E0h	USER_DATA_00	-	BR	8	ASCII	
E1h	FW_SEC_REVISION	-	BR	8	ASCII	
F1h	ISP_UNLOCK_CODE	-	BR/W	4	ASCII	00h,00h,00h,00h
F2h	ISP_CTRL_CMD	-	W	1	Bitmapped	MAP and ISP Mode
F3h	ISP_STATUS_BYTE	-	R	1	Bitmapped	MAP and ISP Mode
F5h	ISP_FLASH_DATA	-	BR/W	16	Direct	ISP Mode only

PMBUS™ SPECIFICATIONS

The LCM300W-T-4 Supported PMBus™ Command List:

Command Code	Command Name	Default Value	Access Type	Data Bytes	Data Format	Description
00h	PAGE	00	R	1	Bitmapped	
01h	OPERATION	80	R/W	1	Bitmapped	Used to Turn the unit ON/OFF in conjunction with the input CONTROL pin. It is also used to set output to upper or lower Margin Voltages
02h	ON_OFF_CONFIG	1E	R		Bitmapped	Configures the combination of CONTROL pin and serial communication commands needed to turn the Unit ON/OFF
03h	CLEAR_FAULTS	-	S	0	-	
10h	WRITE_PROTECT	80	R/W	1	Bitmapped	Used to Control Writing to the PMBus Device 80h - Disables write except 10h 40h - Disables write except 10h, 01h, 00h 20h - Disables write except 10h, 01h, 00h, 02h and 21h commands 00 - Enables write to all writeable commands
15h	STORE_USER_ALL	-	S	0	-	
19h	CAPABILITY	90	R	1	Bitmapped	Provides a way for the hosts system to determine some key capabilities of a PMBus device
1Ah	QUERY	-	BW-BR-PC		Bitmapped	
20h	VOUT_MODE	18	R	1	Linear	Specifies the mode and parameters of Output Voltage related Data Formats
21h	VOUT_COMMAND	2FEB	R	2	Linear	Set output voltage at 48V. Valid Range:38.39-67.21V
24h	VOUT_MAX	3C0	R	2	Linear	Sets the max adjustable output voltage limit. 60V
30h	COEFFICIENTS	-	BW-BR-PC	2/5	Raw Hex	m = 1, b = 0, R = 0
35h	VIN_ON	EA94	R	2	Linear	Sets the value of input, in volts, at which the unit should start. AC GOOD 82.5 Vac
36h	VIN_OFF	EA54	R	2	Linear	Sets the value of input, in volts, at which the unit should stop power conversion. AC BAD 74.5 Vac
3Ah	FAN_CONFIG_1_2	90	R	1	Bitmapped	Read only to reflect setting of Fans
3Bh	FAN_COMMAND_1	0	R/W	2	Linear	Adjusts the operation of the Fans. The device may override the command, if it requires higher value, to maintain proper device temperature. Duty cycle Control – Commands Speeds from 0 to 100%
40h	VOUT_OV_FAULT_LIMIT	Varies	R	2	Linear	135% of VOUT_COMMAND value Writeable in factory configuration mode for testing only max value is 63V

PMBUS™ SPECIFICATIONS

The LCM300W-T-4 Supported PMBus™ Command List:

Command Code	Command Name	Default Value	Access Type	Data Bytes	Data Format	Description
41h	VOUT_OV_FAULT_RESPONSE	80	R	1	MSF	Unit Latches OFF. Resets on PSON or CONTROL pin recycle or AC recycle.
42h	VOUT_OV_WARN_LIMIT	Varies	R	2	Linear	102% of VOUT_COMMAND value Writeable in factory configuration mode for testing only. @12V,48.96V
43h	VOUT_UV_WARN_LIMIT	Varies	R	2	Linear	98% of VOUT_COMMAND value Writeable in factory configuration mode for testing only. @48V, 47.04V
44h	VOUT_UV_FAULT_LIMIT	Varies	R	2	Linear	85% of VOUT_COMMAND value Writeable in factory configuration mode for testing only. @48V,40.80V
45h	VOUT_UV_FAULT_RESPONSE	80	R	1	Bitmapped	Turn PSU OFF
46h	IOUT_OC_FAULT_LIMIT	CB98	R	2	Linear	
47h	IOUT_OC_FAULT_RESPONSE	FA	R	1	Bitmapped	OCP ride through. If OCP persists.
4Ah	IOUT_OC_WARN_LIMIT	CB3C	R	2	Linear	90% of IOUT_OC_FAULT_LIMIT value @48V,6.47A
4Fh	OT_FAULT_LIMIT	E3C0	R	2	Linear	Secondary ambient temperature Fault threshold, in degree C.
50h	OT_FAULT_RESPONSE	C0	R	1	Bitmapped	Turn PSU OFF and will retry indefinitely. Supported enable/disable of protection and recoverability.
51h	OT_WARN_LIMIT	E370	R	2	Linear	Secondary ambient temperature warning threshold,
55h	VIN_OV_FAULT_LIMIT	FA1C	R	2	Linear	Sets input over-voltage threshold. (270Vac) Valid Range: 264 to 300Vac
56h	VIN_OV_FAULT_RESPONSE	80	R	1	Bitmapped	
59h	VIN_UV_FAULT_LIMIT	EA80	R	2	Linear	Default: 80 Vac Valid Rang: 70 to 90 Vac
5Ah	VIN_UV_FAULT_RESPONSE	C0	R	1	Bitmapped	
5Eh	POWER_GOOD_ON	Varies	R	2	Linear	98% of VOUT_COMMAND value
5Fh	POWER_GOOD_OFF	Varies	R	2	Linear	98% of VOUT_COMMAND value
60h	TON_DELAY	0	R	2	Linear	Sets the time (sec), from start condition (Power ON) until the output starts to rise. (0-32767uS)
61h	TON_RISE	E210	R	2	Linear	Sets the time (ms), for the output rises from 0 to regulation. (33ms)
64h	TOFF_DELAY	C2CD	R	2	Linear	Sets the time (ms), from a stop condition (Power OFF) until the output starts to drop (converter OFF),(2.8ms) Valid Range:0-32.7ms
6Ah	POUT_OP_WARN_LIMIT	FAC6	R	2	Linear	Vout_Cmd*Iout_OCP_level*1.03

PMBUS™ SPECIFICATIONS

The LCM300W-T-4 Supported PMBus™ Command List:

Command Code	Command Name	Default Value	Access Type	Data Bytes	Data Format	Description
78h	STATUS_BYTE	00	R	1	Bitmapped	Returns the summary of critical faults
	b7 – BUSY					A fault was declared because the device was busy and unable to respond.
	b6 – OFF					Unit is OFF
	b5 – VOUT_OV					Output over-voltage fault has occurred
	b4 – IOUT_OC					Output over-current fault has occurred
	b3 – VIN_UV					An input under-voltage fault has occurred
	b2 – TEMPERATURE					A temperature fault or warning has occurred
	b1 – CML					A communication, memory or logic fault has occurred.
	b0 – NONE OF THE ABOVE					A Fault Warning not listed in bits[7:1] has occurred.
79h	STATUS_WORD	0000	R	2	Bitmapped	Summary of units Fault and warning status.
	b15 – VOUT					An output voltage fault or warning has occurred
	b14 – IOUT/POUT					An Output current or power fault or warning has occurred.
	b13 – INPUT					An input voltage, current or power fault or warning as occurred.
	b12 – MFR					A manufacturer specific fault or warning has occurred.
	b11 – POWER_GOOD#					The POWER_GOOD signal is de-asserted
	b10 – FANS					A fan or airflow fault or warning has occurred.
	b9 – OTHER					A bit in STATUS_OTHER is set.
	b8 – UNKNOWN					A fault type not given in bits [15:1] of the STATUS_WORD has been detected.
	b7 – BUSY					A fault was declared because the device was busy and unable to respond.
	b6 – OFF					Unit is OFF
	b5 – VOUT_OV					Output over-voltage fault has occurred
	b4 – IOUT_OC					Output over-current fault has occurred
	b3 – VIN_UV					An input under-voltage fault has occurred
	b2 – TEMPERATURE					A temperature fault or warning has occurred
	b1 – CML					A communication, memory or logic fault has occurred.
	b0 – NONE_OF_THE_ABOVE					A fault or warning not listed in bits[7:1] of this byte has occurred.

PMBUS™ SPECIFICATIONS

The LCM300W-T-4 Supported PMBus™ Command List:

Command Code	Command Name	Default Value	Access Type	Data Bytes	Data Format	Description
7Ah	STATUS_VOUT	00	R	1	Bitmapped	Output voltage related faults and warnings
	b7					VOUT Over-voltage Fault
	b6					VOUT Over-voltage warning
	b5					VOUT Under-voltage Warning
	b4					VOUT Under-voltage Fault
	b3					Not supported
	b2					Not supported
	b1					Not supported
7Bh	STATUS_IOUT	00	R	1	Bitmapped	Output Current related faults and warnings
	b7					IOUT Over current Fault
	b6					IOUT Over current And Low Voltage shutdown Fault
	b5					VOUT Under-voltage Warning
	b4					VOUT Under-voltage Fault
	b3					VOUT_MAX Warning, an attempt has been made to set output to a value higher than the highest permissible voltage.
	b2					TON_MAX_FAULT
	b1					TOFF_MAX Warning
	b0					reserved
7Ch	STATUS_INPUT	-	R	1	Bitmapped	
7Dh	STATUS_TEMPERATURE	00	R	1	Bitmapped	Temperature related faults and warnings
	b7					Overtemperature Fault
	b6					Overtemperature Warning
	b5					Undertemperature Warning
	b4					Undertemperature Fault
b3:0					Reserved	
7Eh	STATUS_CML	00	R	1	Bitmapped	Communications, Logic and Memory
80h	STATUS_MFR_SPECIFIC	00	R	1	Bitmapped	Manufacturer Status codes
81h	STATUS_FANS_1_2	00	R	1	Bitmapped	
87h	READ_EOUT	-	BR	6	Linear	Returns the accumulated output power over time
8Bh	READ_VOUT	-	R	2	Linear	Returns the actual, measured voltage in Volts.
8Ch	READ_IOUT	-	R	2	Linear	Returns the output current in amperes.
8Dh	READ_TEMPERATURE_2	-	R	2	Linear	PSU's inter hot spot temperature typically that of the main output rail heat sink. Format is Linear-11

PMBUS™ SPECIFICATIONS

The LCM300W-T-4 Supported PMBus™ Command List:

Command Code	Command Name	Default Value	Access Type	Data Bytes	Data Format	Description
90h	READ_FAN_SPEED	-	R	2	Linear	Speed of Fan
96h	READ_POUT	-	R	2	Linear	Returns the output power, in Watts.
98h	PMBUS_REVISION	22h	R	1	Linear	Reads the PMBus revision number
99h	MFR_ID	"Artesyn"	BR	7	ASCII	Abbrev or symbol of manufacturers name.
9Ah	MFR_MODEL	"LCM300W-T-4"	BR	11	ASCII	Manufacturers Model number
9Bh	MFR_REVISION	"0A "	BR/W	2	ASCII	Manufacturers, revision number
9Ch	MFR_LOCATION	"Philippines "	BR/W	11	ASCII	Manufacturers facility
9Dh	MFR_Date	"YYWWDD"	BR/W	4	ASCII	Manufacture Date structure : YYMMDD
9Eh	MFR_SERIAL		BR/W	13	ASCII	Manufacture series number
A0h	MFR_VIN_MIN	EB20	R	2	Linear	Minimum Input Voltage (100Vac)
A1h	MFR_VIN_MAX	F3C0	R	2	Linear	Maximum Input Voltage (240Vac)
A2h	MFR_IIN_MAX	CA80	R	2	Linear	Maximum Input Current (5A)
A3h	MFR_PIN_MAX	-	R	2	Linear	Default:411.75 W
A4h	MFR_VOUT_MIN	280	R	2	Linear	Minimum Output Voltage Regulation Window. (43V)
A5h	MFR_VOUT_MAX	3C0	R	2	Linear	Maximum Output Voltage. Regulation Window (60V)
A6h	MFR_IOUT_MAX	CB20	R	2	Linear	Maximum Output Current (6.25A)
A7h	MFR_POUT_MAX	FA58	R	2	Linear	Maximum Output Power (300W for High Line and 1000 For Low Line)
A8h	MFR_TAMBIENT_MAX	EA30	R	2	Linear	Maximum Operating Ambient Temperature (Secondary Ambient) (70 degC)
A9h	MFR_TAMBIENT_MIN	E580	R	2	Linear	Minimum Operating Ambient Temperature (Secondary Ambient) (-40 degC)
AAh	MFR_EFFICIENCY_LL	100,300,85,300,85,300,85	BR	14	Linear	Default:100,300,85,300,85,300,85
ABh	MFR_EFFICIENCY_HL	230,300,89,300,89,300,89	BR	14	Hex	Default:230,300,89,300,89,300,89
B0h	USER_DATA_00	-	BR/BW	Varies	ASCII	
E0h	FW_PRI_VERSION		BR	8	ASCII	
E1h	FW_SEC_VERSION	-	BR	8	ASCII	
F1h	ISP_UNLOCK_CODE	-	BR/W	4	ASCII	MAP Mode only
F2h	ISP_CTRL_CMD	-	W	1	Bitmapped	MAP and ISP Mode
F3h	ISP_STATUS_BYTE	-	R	1	Bitmapped	MAP and ISP Mode
F5h	ISP_FLASH_DATA	-	BR/W	16	Direct	ISP Mode only

APPLICATION NOTES

Current Sharing

The LCM300 series main output V1 is equipped with current sharing capability. This will allow up to 10 power supplies to be connected in parallel for higher power application. Current share accuracy is typically 10% of full load. Ishare voltage at full load is to be 5.0-6.6 Volts and 2.5-4.0 Volts at 50% of maximum current. The I²C Line should be connected separately when the number of units in parallel is more than 8. The minimum load at parallel operation is 1% of the total Output current that the units can deliver.

The table below shows the derated Maximum Power capacity when units are in parallel configuration. This is to consider the 10% load sharing tolerance.

Number of Units in Parallel (N)	Maximum Output power Rated + [(N-1) x 0.9] x Rated, Where: Rated - 300W, N - Number of PSU in Parallel
Stand-alone	300W
2	570W
3	840W
..	..
....
10	2730W

Supports redundant operation up to 10 units in parallel.

APPLICATION NOTES

Output Ripple and Noise Measurement

The setup outlined in the diagram below has been used for output voltage ripple and noise measurements on the LCM300 series. When measuring output ripple and noise, a scope jack in parallel with a 0.1mF ceramic chip capacitor, and a 10mF Tantalum capacitor should be used. Oscilloscope should be set to 20 MHz bandwidth for this measurement.

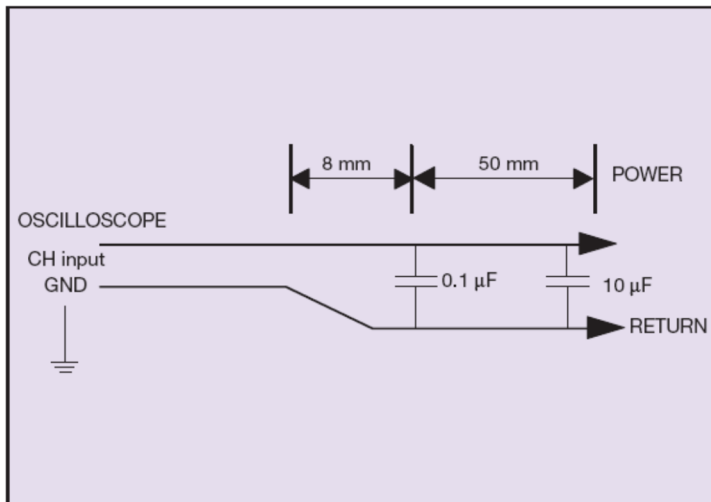

RECORD OF REVISION AND CHANGES

Issue	Date	Description	Originators
1.0	08.10.2015	First Issue	G. Xue
1.1	01.12.2016	Updated the I ² C detail	G. Xue
1.2	05.03.2016	Update the page 2 module number/Update the remote sense description	K. Wang
1.3	04.13.2017	Add LCM300L and LCM300N	K.Ma
1.4	05.22.2017	Update the OCP and SCP description/Update the output voltage adjust range of LCM300N and LCM300W	K.Ma
1.5	03.01.2018	Update the 9Dh to MFR_Date. Add 9Eh.	K. Wang
1.6	03.09.2018	Update 3B to R/W	K. Wang
1.7	05.09.2019	Update mating connector Update the PFC Frequency	K. Wang
1.8	01.14.2019	Update the VIN_OV_FAULT_LIMIT default value	K. Wang
1.9	03.19.2019	Update mating connector	K. Wang
2.0	03.25.2020	Update isolation voltage (Production)	J. Ma
2.1	04.14.2020	Update mating connector	K. Ma
2.2	05.08.2020	Update the leakage current for different test method	K. Ma
2.3	07.01.2020	1. Update safety cert from 60950 to 62368 2. Update 21h command	K. Ma
2.4	07.01.2021	Update the output voltage adjust range of LCM300N and LCM300W	K. Ma
2.5	08.18.2021	Update PMBus™ command list Update PMBus address pins internal pull up voltage Update safety approvals	K. Ma
2.6	01.20.2022	Update EMC part Add UKCA mark and PMBus logo Update minimum SCL frequency Add SK4 and SK5 mating connector	K. Ma
2.7	02.14.2022	Update timing diagram Update the connector pinout view	J. Zhang K. Ma
2.8	08.30.2022	Update isolation voltage typo	K. Ma
2.9	04.18.2023	Add note for the maximum output power on LCM300 Q and U variant	K. Ma
3.0	07.18.2023	Add trim pot location in mechanical drawing	K. Ma
3.1	09.05.2023	Add "Supports redundant operation up to 10 units"	K. Ma
3.2	06.26.2024	Update operating altitude spec to 10,000 feet	K. Ma
3.3	11.06.2024	Update 5VSB total regulation	K. Ma
3.4	03.15.2025	Update operating altitude spec of 10,000 feet in altitude part	K. Ma



For international contact information,
visit advancedenergy.com.

powersales@aei.com (Sales Support)
productsupport.ep@aei.com (Technical Support)
+1 888 412 7832

ABOUT ADVANCED ENERGY

Advanced Energy (AE) has devoted more than three decades to perfecting power for its global customers. AE designs and manufactures highly engineered, precision power conversion, measurement and control solutions for mission-critical applications and processes.

Our products enable customer innovation in complex applications for a wide range of industries including semiconductor equipment, industrial, manufacturing, telecommunications, data center computing, and medical. With deep applications know-how and responsive service and support across the globe, we build collaborative partnerships to meet rapid technological developments, propel growth for our customers, and innovate the future of power.

PRECISION | POWER | PERFORMANCE | TRUST

Specifications are subject to change without notice. Not responsible for errors or omissions. ©2020 Advanced Energy Industries, Inc. All rights reserved. Advanced Energy®, and AE® are U.S. trademarks of Advanced Energy Industries, Inc.