

ARTESYN CNS650-M SERIES

650 Watts (forced air)
400 Watts (convection)



PRODUCT DESCRIPTION

Advanced Energy's Artesyn CNS650-MU series of single output open-frame AC-DC power supplies are offered in 12 V, 24 V, or 48 V outputs with +15% Trim range. Each power supply comes with a 12 V fan output and 5 V standby. All models feature ITE and medical safety approvals and accept a universal input of 90 to 264 Vac. Depending on operating conditions, its 4 x 6 x 1.54 in compact and high density "U-Channel" Construction delivers up to 400 watts of output power with free air convection cooling and up to 650 watts with 400 LFM of forced air. These power supplies are ideal for industrial systems as well as for medical applications.

SPECIAL FEATURES

- Designed for forced air and natural convection cooling
- Medical and ITE safety approvals, 2x MOPP
- PMBus™ interface
- Active current share with OR-ing FET
- Dual fused
- Type BF ready
- Active Power Factor Correction, 61000-3-2 compliant
- Built-in Class B EMI filter
- Less than 1U high
- 4" x 6" U-channel construction (open-frame or end-fan variants available for 12V)
- <500 mW no-load power consumption

- 80 PLUS certified (-ME model)
- Three-year warranty (consult factory for extended terms)

SAFETY

- UL/CSA ES60601-1/C22.2 No. 60601-1
UL/CSA 62368-1
- TÜV EN 60601-1
- DEMKO EN 62368-1
- CB IEC 60601-1
IEC 62368-1
- CCC GB4943.1/GB9254;
GB17625.1
- CE Mark
- UKCA Mark

** CNS650-M tested according to the medical standard IEC 60601-1 3.1 Edition.

AT A GLANCE

Total Power

400 to 650 Watts

Input Voltage

90 to 264 Vac

of Outputs

Main, Standby and Fan



MODEL NUMBERS

Standard	Output Voltage	Minimum Load	Maximum Load (Convection)	Peak Load (Convection) ¹	Maximum Load (Forced Air) ²	Peak Load (Forced Air) ²	Standby ⁶
CNS653-MU ³	12.0Vdc	0A	33.3A	54.2A	54.2A	62.5A	5Vdc@2A
CNS653-ME ^{4,7}	12.0Vdc	0A	54.2A	62.5A	NA	NA	5Vdc@2A
CNS653-MF ⁵	12.0Vdc	0A	30.8A	54.2A	54.2A	62.5A	5Vdc@2A
CNS655-MU	24.0Vdc	0A	16.7A	27.1A	27.1A	31.3A	5Vdc@2A
CNS658-MU	48.0Vdc	0A	8.3A	13.5A	13.5A	15.6A	5Vdc@2A

Note 1 - Peak load current not to exceed 10 seconds.
 Note 2 - Requires at least 400 LFM of airflow.
 Note 3 - "MU" for U-Channel construction.
 Note 4 - "ME" for built-in End-Fan with cover and IEC inlet.
 Note 5 - "MF" for Open Frame construction.
 Note 6 - 2A with forced air cooling or 1A at natural convection.
 Note 7 - 80 PLUS Certified.
 Note 8 - 12Vdc Fan voltage supply available via connector J306 or J304 (pins 9 & 11). Rated 1A with forced air or 0.5A at natural convection.

Options

None

ELECTRICAL SPECIFICATIONS

Absolute Maximum Ratings

Stress in excess of those listed in the “Absolute Maximum Ratings” may cause permanent damage to the power supply. These are stress ratings only and functional operation of the unit is not implied at these or any other conditions above those given in the operational sections of this TRN. Exposure to any absolute maximum rated condition for extended periods may adversely affect the power supply’s reliability.

Table 1. Absolute Maximum Ratings						
Parameter	Model	Symbol	Min	Typ	Max	Unit
Input Voltage AC continuous operation	All models	$V_{IN,AC}$	90	-	264	Vac
Maximum Output Power (Main + Stand-by)	All models	$P_{O,max}$	-	-	650	W
Isolation Voltage	Input to Output	All models	-	-	4,000	Vac
	Input to Earth Ground	All models	-	-	1,500	Vac
	Output to Earth Ground	All models	-	-	1,500	Vac
Production Hi-pot	Input to Output for 3 sec	All models	-	-	1,800	Vac
	Input to Earth Ground for 3 sec	All models	-	-	1,500	Vac
	Output to Earth Ground for 3 sec	All models	-	-	264	Vac
Ambient Operating Temperature	All models	T_A	-20	-	+80 ¹	°C
Startup Temperature	All models	$T_{startup}$	-40	-	-	°C
Storage Temperature	All models	T_{STG}	-40	-	+85	°C
Relative Humidity (non-condensing)	Operating	All models	5	-	95	%
	Non-operating	All models	5	-	95	%
Altitude	Operating	All models	-10	-	5,000 ²	m
	Non-operating	All models	-	-	10,000	m

Note 1 - No power derating up to 50°C, linear derating to 80°C.

Note 2 - Operating altitude up to 3,000m for Medical, 5,000m for ITE.

ELECTRICAL SPECIFICATIONS

Input Specifications

Table 2. Input Specifications							
Parameter	Condition	Symbol	Min	Typ	Max	Unit	
Operating Input Voltage	All	$V_{IN,AC}$	90	115/230	264	Vac	
		$V_{IN,DC}$	127	-	350 ¹	Vdc	
Turn on Input Voltage	All	$V_{IN,AC}$	-	87	90	Vac	
Turn off Input Voltage	All	$V_{IN,AC}$	80	82	-	Vdc	
Input AC Frequency ²	All	$f_{IN,AC}$	47	50/60	63	Hz	
			360	-	400	Hz	
Maximum Input Current ($I_O = I_{O,max}$, $I_{SB} = I_{SB,max}$)	$V_{IN,AC} = 90Vac$	$I_{IN,max}$	-	-	9.2	Arms	
Standby Input Power ³ ($V_O = Off$, $I_{SB} = 0A$)	All	$P_{IN,SB}$	-	-	0.5	W	
No Load Input Power(12V, 24V model) ($V_O = On$, $I_O = 0A$, $I_{SB} = 0A$)	$V_{IN,AC} = 90Vac$	$P_{IN, no-load}$			3	W	
No Load Input Power(48V model) ($V_O = On$, $I_O = 0A$, $I_{SB} = 0A$)	$V_{IN,AC} = 90Vac$	$P_{IN, no-load}$			5	W	
Harmonic Line Current	Full Load	THD	-	-	20	%	
Power Factor ⁴	230Vac, Full Load 115Vac, Full Load		0.95 0.98	- -	- -		
Inrush Current @ 25°C	$V_{IN,AC} = 264Vac$ Cold Start	$I_{IN,surge}$	-	-	50	A _{PK}	
Input Fuse	Both L and N		-	-	12	A	
Turn On Delay	By AC Mains		-	-	2	S	
	By Inhibit		-	-	1.5	S	
Leakage Current	UL test method		-	-	300	uA	
Efficiency	25degC, Without Standby & Fan	230Vac, Full Load	η	92.5	93.0	-	%
		230Vac, Half Load	η	92.5	93.0	-	%
		115Vac, Full Load	η	90.0	90.5	-	%
		115Vac, Half Load	η	91.0	91.5	-	%

Note 1 - Tested and characterized up to 400Vdc but safety approved up to 350Vdc only.

Note 2 - Characterized and tested for 360-400Hz operation but not part of safety approval.

Leakage/touch current will be higher and will not meet medical requirements.

Note 3 - To achieve the input power lower than 0.5W, the PMBus communication and all signals are disabled except the inhibit pin.

Note 4 - Rated power factor is for 47 to 63 Hz input frequency only. Power factor will be lower at 360 to 400 Hz input frequency.

ELECTRICAL SPECIFICATIONS

Output Specifications

Table 3. Output Specifications							
Parameter	Condition	Symbol	Min	Typ	Max	Unit	
Output Power (Convection, Continuous, Open Frame, “-MF” Suffix)	$T_A=50^{\circ}\text{C}$ $V_{IN}=90\text{Vac}$ $V_{IN}=180\text{Vac}$		0	-	305	W	
			0	-	370	W	
Output Power (Convection, Continuous, U-Channel, “-MU” Suffix)	$T_A=50^{\circ}\text{C}$ $V_{IN}=90\text{Vac}$ $V_{IN}=180\text{Vac}$		0	-	345	W	
			0	-	410	W	
Output Power (Forced-Air, Continuous, End Fan, , “-ME” Suffix)	$T_A=50^{\circ}\text{C}$ $V_{IN}=90\text{-}264\text{Vac}$ Air flow=200LFM Air flow=400LFM		0	-	550	W	
			0	-	650	W	
Output Setpoint Voltage (Factory)	CNS653-MX ¹ CNS655-MU CNS658-MU	Inclusive of setpoint, temperature change, warm-up drift	V_O	11.88	12.0	12.12	V
	All Models			23.76	24.0	24.24	
			V_{Standby}	-	5.0	-	
Output Voltage Adjustability	CNS653-MX CNS655-MU CNS658-MU	% of Setpoint		100	-	115	% V_O
Output Ripple, pk-pk	All Models	Measure with a 0.1uF ceramic capacitor in parallel with a 10uF tantalum capacitor, 0 to 20MHz bandwidth	% V_O	-	-	1	%
Fan Output Voltage	All Models		V_{fan}	-	12	-	V
Fan Output Current (Convection, Continuous)	All Models		$I_{\text{fan, convection}}$	-	0.5	-	A
Fan Output Current (Forced-Air, Continuous)	All Models		$I_{\text{fan, forced-air}}$	-	1.0	-	A
Line Regulation	All Models			-2	-	2	%
Load Regulation	All Models			-2	-	2	%
Standby Output Voltage ²	All Models		V_{SB}	-	5	-	Vdc
Standby Output Current (Convection, Continuous)	All Models		$I_{O, \text{Standby}}$	0.06	1	-	A
Standby Output Current (Forced-Air, Continuous)	All Models		$I_{O, \text{Standby}}$	0.06	2	-	A
Minimum Load for Current Sharing				10	-	-	% $I_{O, \text{max}}$
Output Current Share Accuracy	20% to 100% $I_{O, \text{max}}$	% $I_{O, \text{max}}$		-	-	5	%A
I_{Share} Voltage	No load			-	-	0.5	Vdc
	50% load			3.85	4	4.15	Vdc
	100% load			7.75	8	8.25	Vdc

Note 1 - “MX” means “MU”, “ME” and “MF”.

Note 2 - If the application will not be using the 5Vsb output, it is recommended to add pre-load at the 5Vsb output to ensure that it will not go into hiccup mode. Suggested preload is 300mW minimum.

ELECTRICAL SPECIFICATIONS

Output Specifications

Table 3. Output Specifications Con't							
Parameter	Condition	Symbol	Min	Typ	Max	Unit	
Number of Parallel Units	Main Output Current Share connected		-	-	2		
Number of Series Units	External Diodes Required		-	-	4		
Output Capacitance			0	-	330	uF/A	
V _O Dynamic Response	Peak Deviation Recovery Time	50% load change, with capacitive load of 330uF/A	±%V _O	-	-	3	%
				-	-	500	uS
MTBF	25°C, 410W convection		9.5	-	-	10 ⁵ hrs	
	25°C, 650W forced air		13	-	-	10 ⁵ hrs	
Hold up time	Convection(400W load)		20	25	-	ms	
	Forced Air(650W load)		12	15	-	ms	

ELECTRICAL SPECIFICATIONS

CNS653-MX Performance Curves

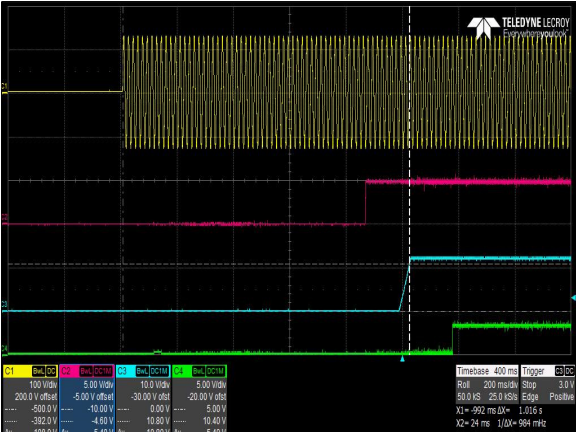

Figure 1: CNS653-ME Turn-on delay by AC Mains – Vin = 90Vac
 Load: $I_O = 54.2A$, $I_{SB} = 2A$
 Ch 1: V_{IN} Ch 2: V_{SB} Ch 3: V_O Ch 4: PWOK

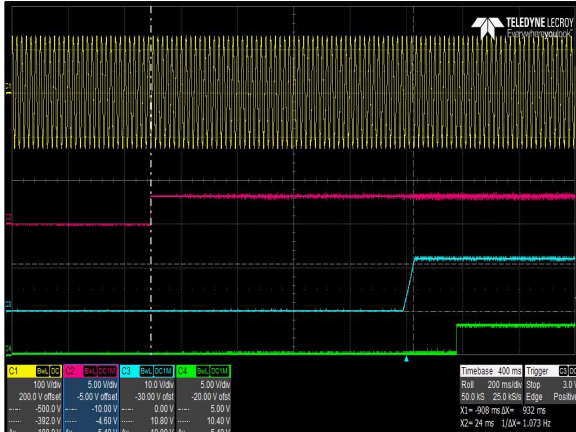

Figure 2: CNS653-ME Turn-on delay by Inhibit – Vin = 90Vac
 Load: $I_O = 54.2A$, $I_{SB} = 2A$
 Ch 1: V_{IN} Ch 2: Inhibit Ch 3: V_O Ch 4: PWOK

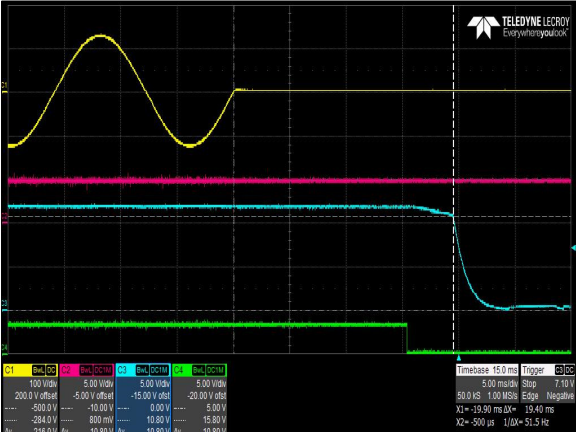

Figure 3: CNS653-ME Hold-up Time – Vin = 90Vac / 63Hz / 0°
 Load: $I_O = 54.2A$, $I_{SB} = 2A$
 Ch 1: V_{IN} Ch 2: V_{SB} Ch 3: V_O Ch 4: PWOK

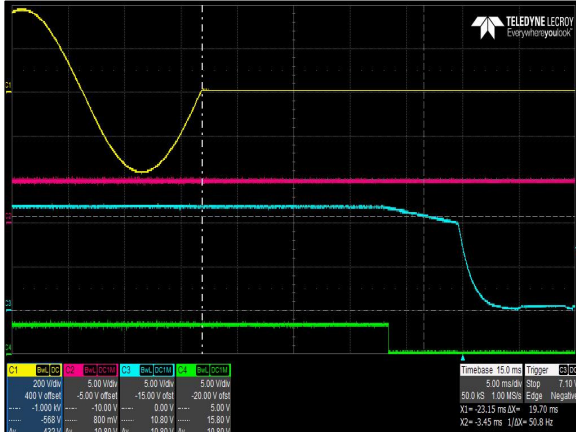

Figure 4: CNS653-ME Hold-up Time – Vin = 264Vac / 47Hz / 0°
 Load: $I_O = 54.2A$, $I_{SB} = 2A$
 Ch 1: V_{IN} Ch 2: V_{SB} Ch 3: V_O Ch 4: PWOK

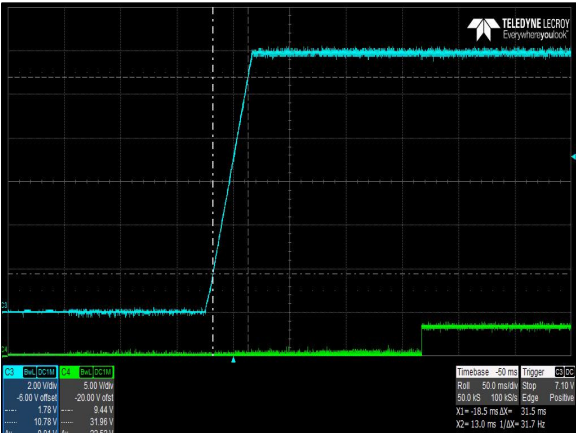

Figure 5: CNS653-ME Output Voltage Startup Characteristic
 $V_{IN} = 90Vac$, Load: $I_O = 54.2A$
 Ch 3: V_O Ch 4: PWOK

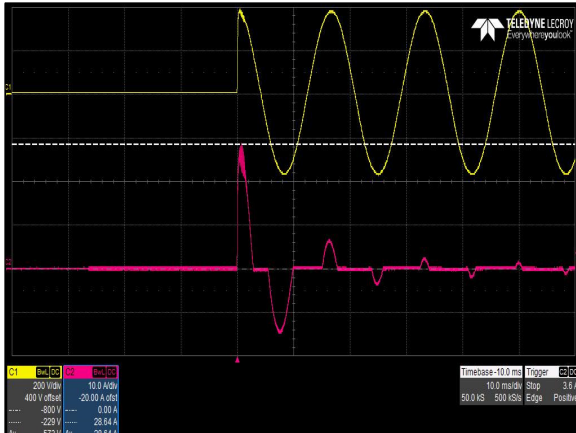

Figure 6: CNS653-ME Inrush Current
 $V_{IN} = 264Vac$, Load: $I_O = 0A$, Turn on angle = 90°
 Ch 1: V_{IN} Ch 2: I_{IN}

ELECTRICAL SPECIFICATIONS

CNS653-MX Performance Curves

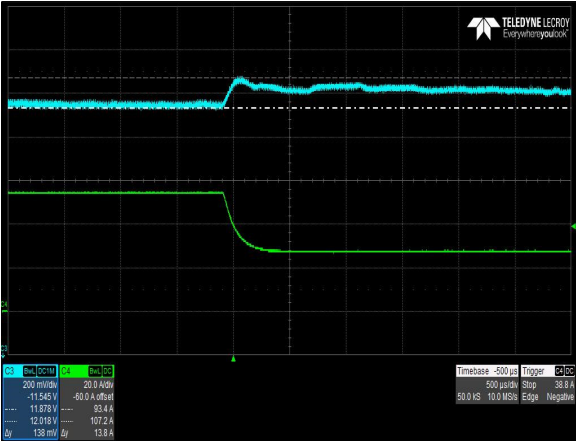

Figure 7: CNS653-ME Transient Response – Vo Deviation
 $V_{IN} = 90\text{Vac}$, $I_O = 100\%$ to 50%, Output Cap = 330uF/A
 Ch 3: V_O Ch 4: I_O

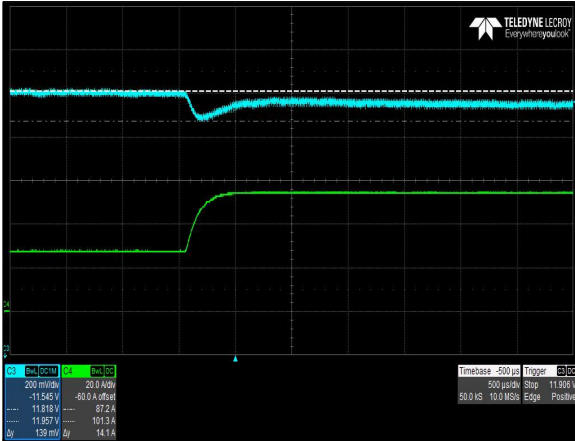

Figure 8: CNS653-ME Transient Response – Vo Deviation
 $V_{IN} = 90\text{Vac}$, $I_O = 100\%$ to 50%, Output Cap = 330uF/A
 Ch 3: V_O Ch 4: I_O

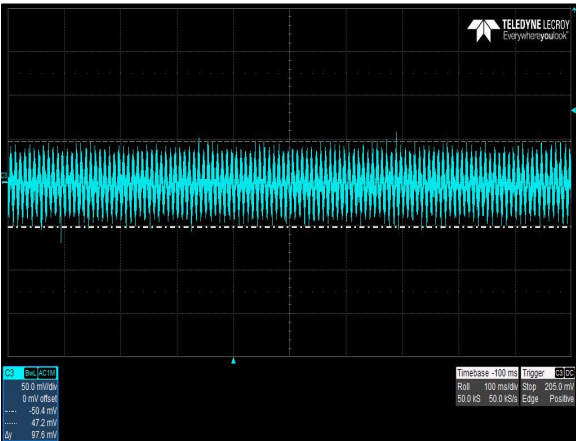

Figure 9: CNS653-ME Ripple and Noise Measurement
 $V_{IN} = 115\text{Vac}$, Load: $I_O = 54.2\text{A}$
 Ch 3: V_O

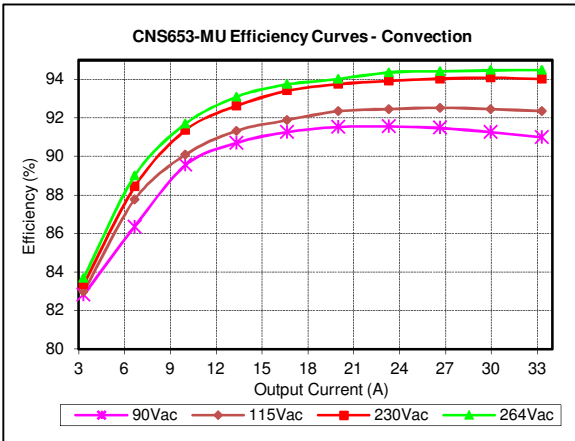

Figure 10: CNS653-MU Efficiency Curves @ 25°C
 Convection Cooling
 $V_{IN} = 90$ to 264Vac, Load: $I_O = 0$ to 33.3A

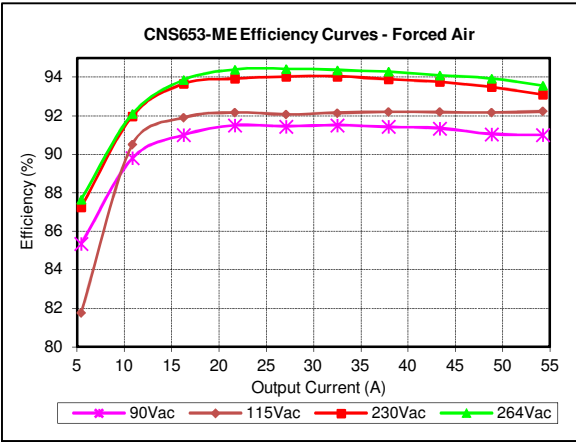

Figure 11: CNS653-ME Efficiency Curves @ 25°C
 Forced Air, Internal Fan
 $V_{IN} = 90$ to 264Vac, Load: $I_O = 0$ to 54.2A

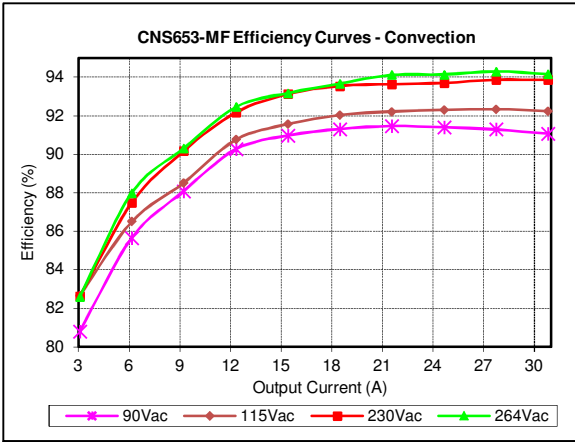

Figure 11: CNS653-MF Efficiency Curves @ 25°C
 Convection Cooling
 $V_{IN} = 90$ to 264Vac, Load: $I_O = 0$ to 30.8A

ELECTRICAL SPECIFICATIONS

CNS655-MU Performance Curves

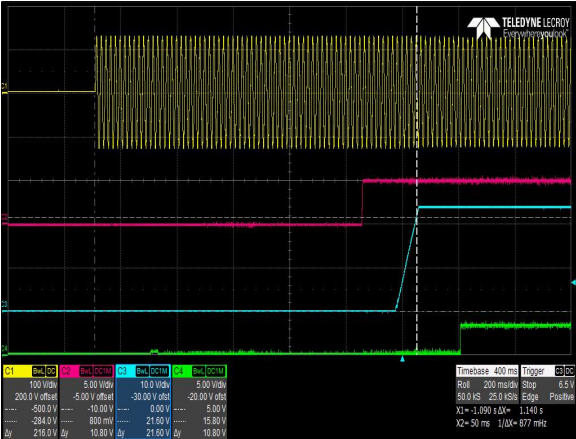

Figure 13: CNS655-MU Turn-on delay by AC Mains – Vin = 90Vac
 Load: I_O = 16.7A, I_{SB} = 1A
 Ch 1: V_{IN} Ch 2: V_{SB} Ch 3: V_O Ch 4: PWOK

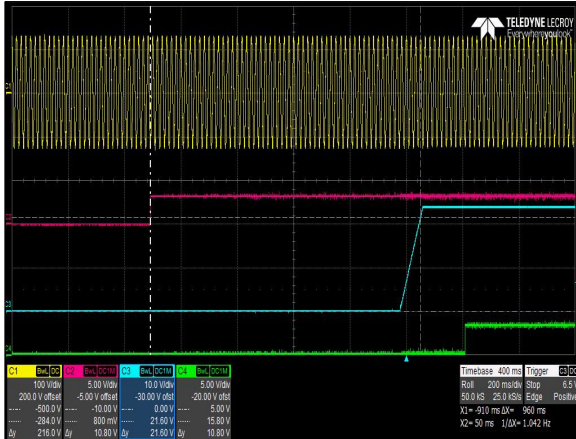

Figure 14: CNS655-MU Turn-on delay by Inhibit – Vin = 90Vac
 Load: I_O = 16.7A, I_{SB} = 1A
 Ch 1: V_{IN} Ch 2: Inhibit Ch 3: V_O Ch 4: PWOK

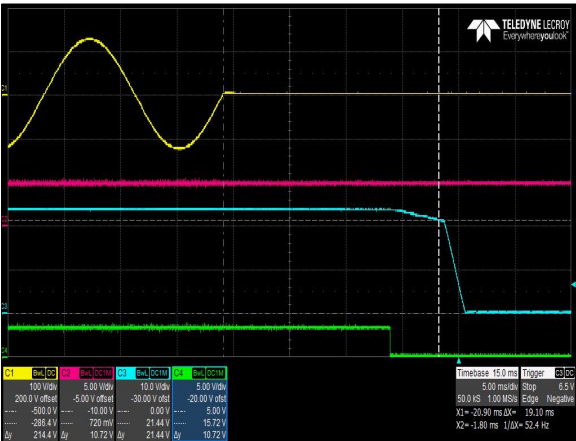

Figure 15: CNS655-MU Hold-up Time – Vin = 90Vac / 63Hz / 0°
 Load: I_O = 16.7A, I_{SB} = 1A
 Ch 1: V_{IN} Ch 2: V_{SB} Ch 3: V_O Ch 4: PWOK

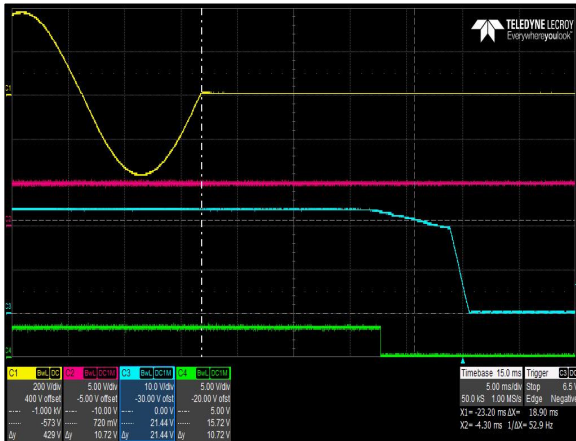

Figure 16: CNS655-MU Hold-up Time – Vin = 264Vac / 47Hz / 0°
 Load: I_O = 16.7A, I_{SB} = 1A
 Ch 1: V_{IN} Ch 2: V_{SB} Ch 3: V_O Ch 4: PWOK

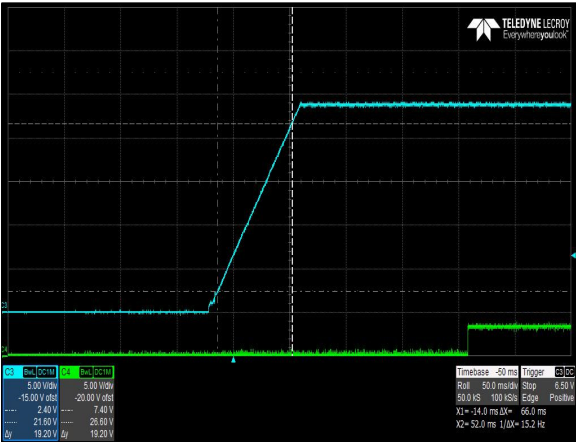

Figure 17: CNS655-MU Output Voltage Startup Characteristic
 Vin = 90Vac, Load: I_O = 16.7A
 Ch 3: V_O Ch 4: PWOK

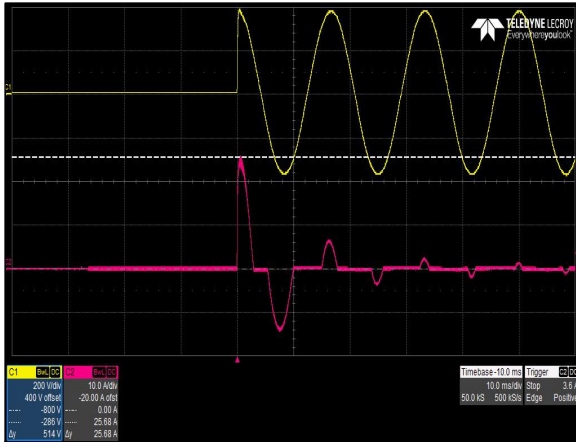

Figure 18: CNS655-MU Inrush Current
 V_{IN} = 264Vac, Load: I_O = 0A, Turn on angle = 90°
 Ch 1: V_{IN} Ch 2: I_{IN}

ELECTRICAL SPECIFICATIONS

CNS655-MU Performance Curves

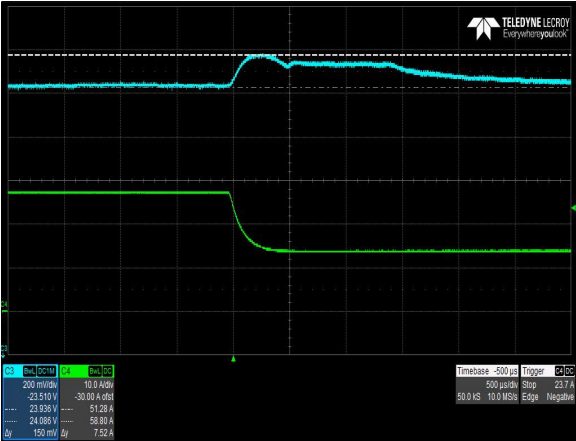

Figure 19: CNS655-MU Transient Response – Vo Deviation
 $V_{IN} = 90Vac, I_O = 100\% \text{ to } 50\%$, Output Cap = 330uF/A
 Ch 3: V_O Ch 4: I_O

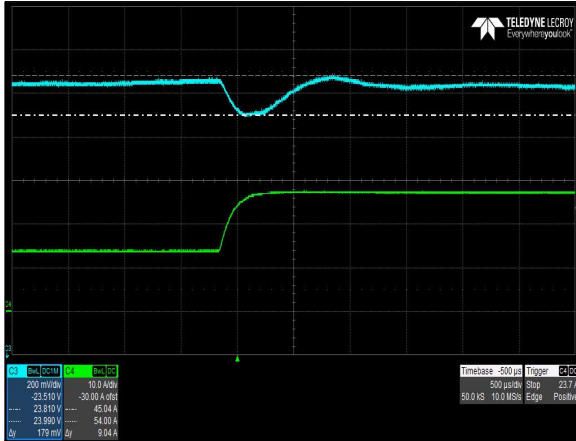

Figure 20: CNS655-MU Transient Response – Vo Deviation
 $V_{IN} = 90Vac, I_O = 100\% \text{ to } 50\%$, Output Cap = 330uF/A
 Ch 3: V_O Ch 4: I_O

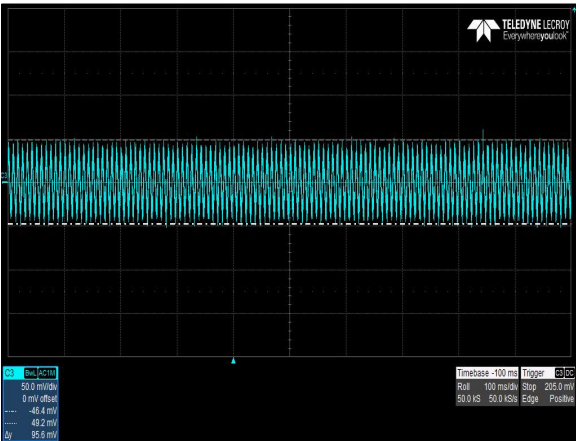

Figure 21: CNS655-MU Ripple and Noise Measurement
 $V_{in} = 115Vac$, Load: $I_O = 16.7A$
 Ch 3: V_O

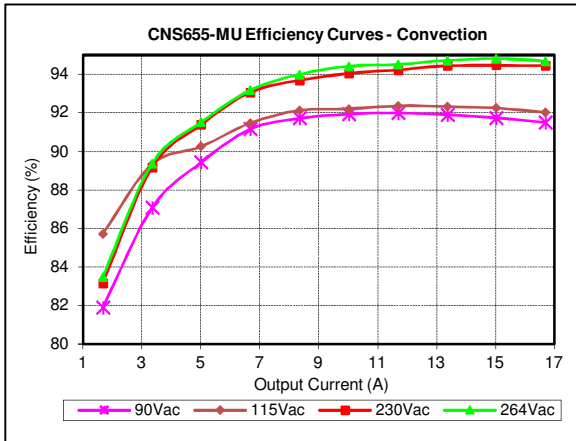

Figure 22: CNS655-MU Efficiency Curves @ 25°C
 Convection Cooling
 $V_{IN} = 90 \text{ to } 264Vac$, Load: $I_O = 0 \text{ to } 16.7A$

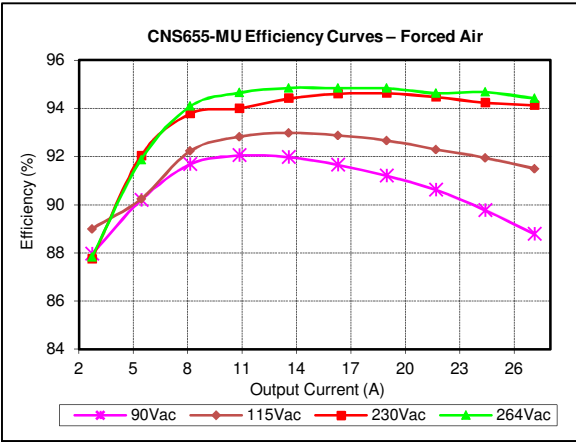

Figure 23: CNS655-MU Efficiency Curves @ 25°C
 Forced Air
 $V_{IN} = 90 \text{ to } 264Vac$, Load: $I_O = 0 \text{ to } 27.1A$

ELECTRICAL SPECIFICATIONS

CNS658-MU Performance Curves

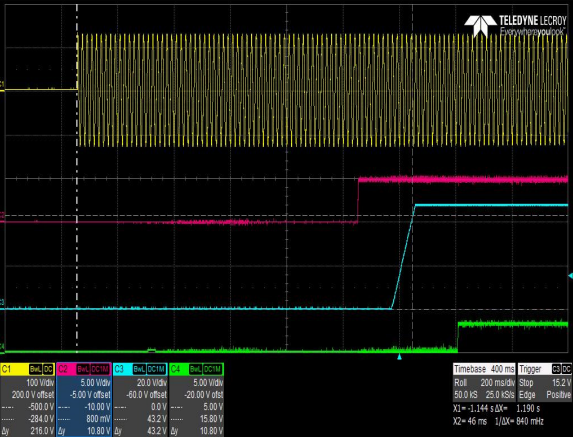

Figure 24: CNS658-MU Turn-on delay by AC Mains – Vin = 90Vac
 Load: $I_O = 8.3A$, $I_{SB} = 1A$
 Ch 1: V_{IN} Ch 2: V_{SB} Ch 3: V_O Ch 4: PWOK

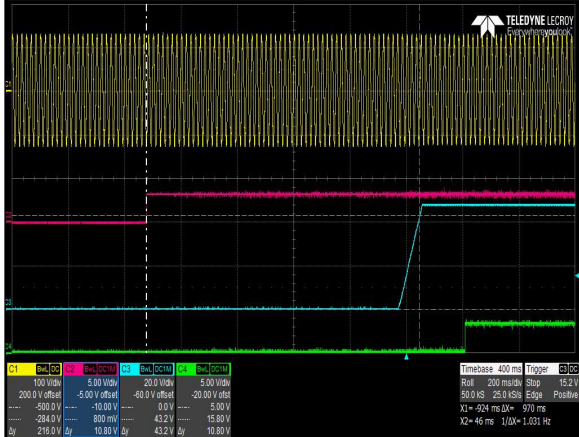

Figure 25: CNS658-MU Turn-on delay by Inhibit – Vin = 90Vac
 Load: $I_O = 8.3A$, $I_{SB} = 1A$
 Ch 1: V_{IN} Ch 2: Inhibit Ch 3: V_O Ch 4: PWOK

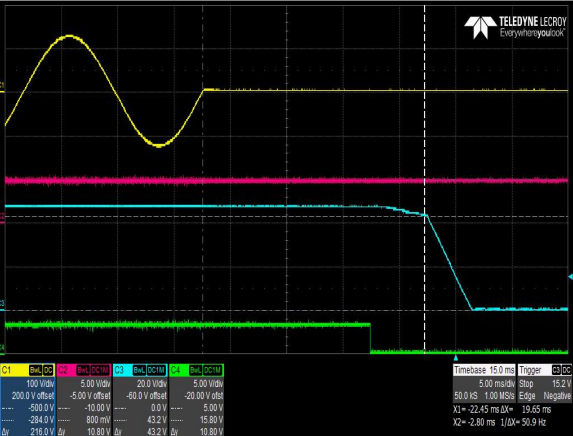

Figure 26: CNS658-MU Hold-up Time – Vin = 90Vac / 63Hz / 0°
 Load: $I_O = 8.3A$, $I_{SB} = 1A$
 Ch 1: V_{IN} Ch 2: V_{SB} Ch 3: V_O Ch 4: PWOK

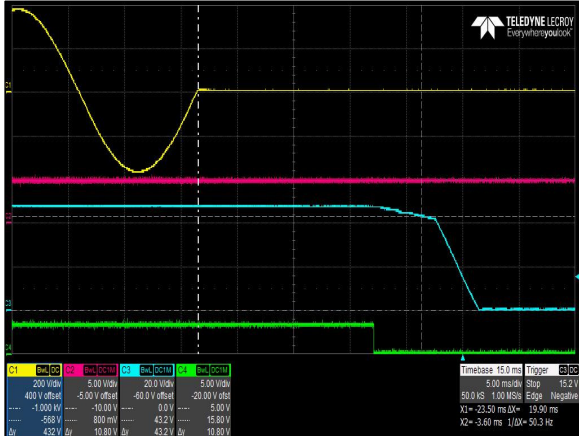

Figure 27: CNS658-MU Hold-up Time – Vin = 264Vac / 47Hz / 0°
 Load: $I_O = 8.3A$, $I_{SB} = 1A$
 Ch 1: V_{IN} Ch 2: V_{SB} Ch 3: V_O Ch 4: PWOK

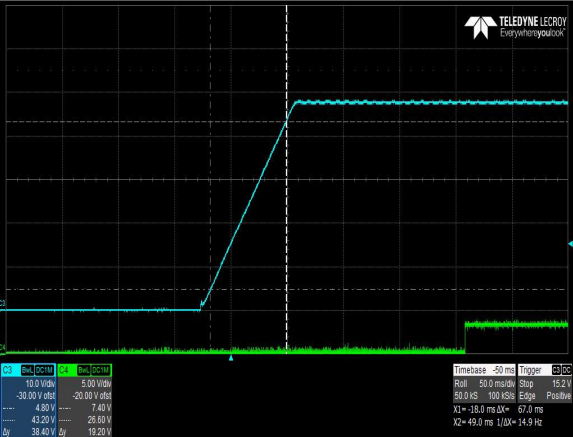

Figure 28: CNS658-MU Output Voltage Startup Characteristic
 Vin = 90Vac, Load: $I_O = 8.3A$
 Ch 3: V_O Ch 4: PWOK

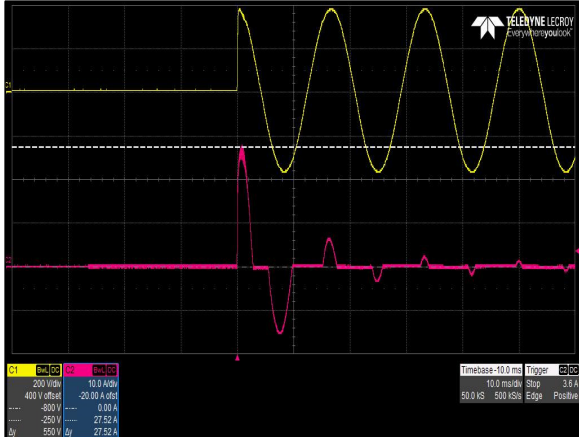

Figure 29: CNS658-MU Inrush Current
 $V_{IN} = 264Vac$, Load: $I_O = 0A$, Turn on angle = 90°
 Ch 1: V_{IN} Ch 2: I_{IN}

ELECTRICAL SPECIFICATIONS

CNS658-MU Performance Curves

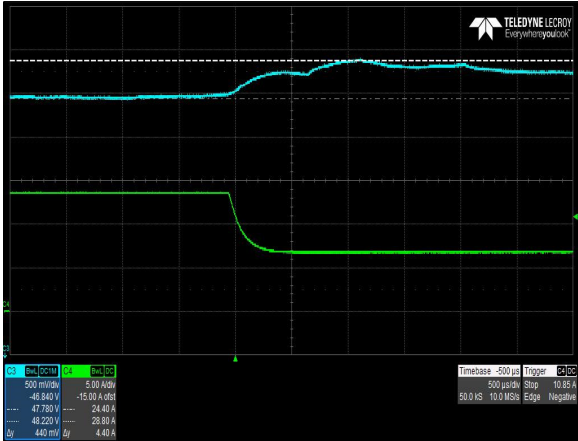

Figure 30: CNS658-MU Transient Response – Vo Deviation
 $V_{IN} = 90\text{Vac}$, $I_O = 100\%$ to 50%, Output Cap = 330 $\mu\text{F/A}$
 Ch 3: V_O Ch 4: I_O

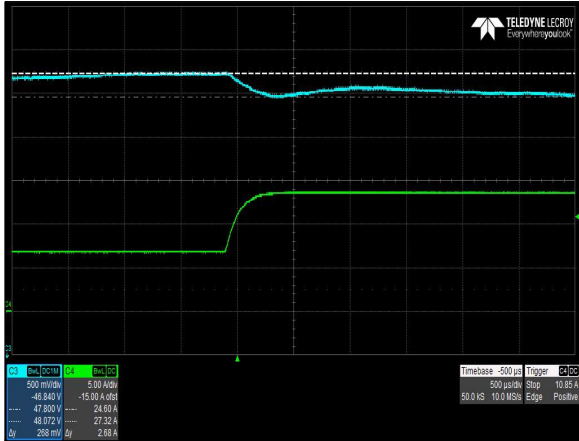

Figure 31: CNS658-MU Transient Response – Vo Deviation
 $V_{IN} = 90\text{Vac}$, $I_O = 100\%$ to 50%, Output Cap = 330 $\mu\text{F/A}$
 Ch 3: V_O Ch 4: I_O

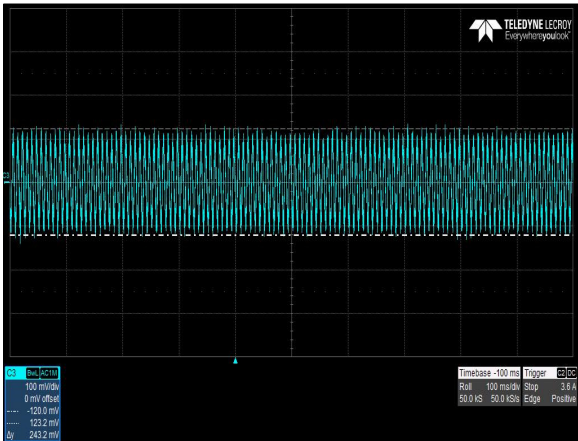

Figure 32: CNS658-MU Ripple and Noise Measurement
 $V_{IN} = 115\text{Vac}$, Load: $I_O = 8.3\text{A}$
 Ch 3: V_O

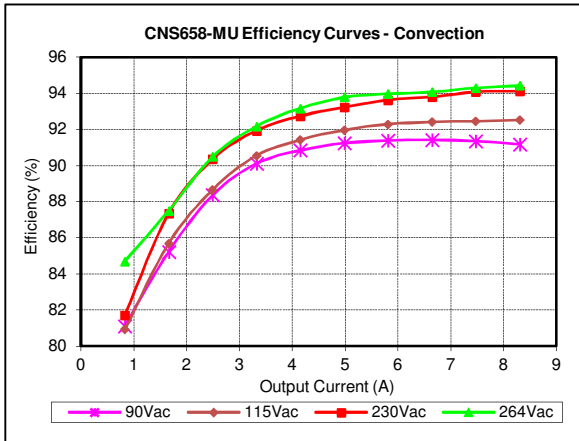

Figure 33: CNS658-MU Efficiency Curves @ 25°C
 Convection Cooling
 $V_{IN} = 90$ to 264Vac, Load: $I_O = 0$ to 8.3A

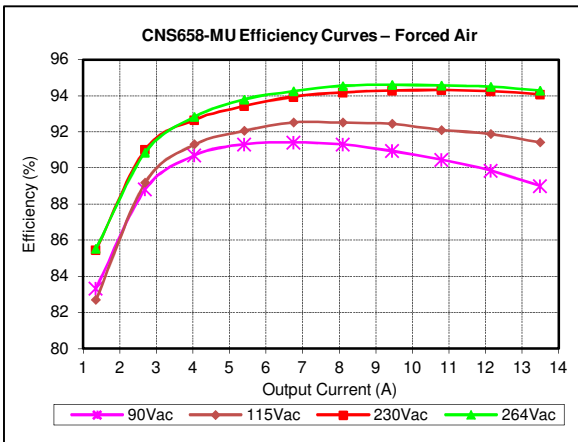

Figure 34: CNS658-MU Efficiency Curves @ 25°C
 Forced Air
 $V_{IN} = 90$ to 264Vac, Load: $I_O = 0$ to 13.5A

ELECTRICAL SPECIFICATIONS

Protection Function Specifications

Input Fuse

CNS650-M series is equipped with internal non user serviceable 12A Fast Acting 500Vac/400Vdc fuses to IEC 60127-2 for fault protection in both L and N input.

Over Voltage Protection (OVP)

The CNS650-M comes with Over Voltage Protection circuit. When the Main Output voltage reaches OVP range, the Main and 12V Fan Outputs will turn-off/latch-off. The 5V Standby will remain On. The AC input will need to be cycled or the Remote Inhibit toggled for the Main and 12V Fan Outputs to reset and turn back on.

If the 5V Standby goes into OVP, the entire power supply will turn-off/latch-off until the AC input is re-cycled or the Remote Inhibit toggled.

Parameter	Min	Typ	Max	Unit
V _O Output Overvoltage	110	/	150	%V _O

Over Current Protection (OCP)

Main Output: In the event of an over current/over load, the Main Output will enter into constant current mode when the output voltage remains within 50%~100% of V_{out} nominal. If V_{out} drops below 50%, the Main and 12V Fan Outputs will shutdown and enter into hiccup mode. The 5V Standby will remain on. The power supply will auto-recover once the fault condition cease to exist. This OCP mode allows for power supply startup and operation with motor loads(inductive) and highly capacitive loads.

5V Standby: An over current/over load on the 5V Standby Output will shut down the entire power supply. The power supply will auto-recover once the fault condition cease to exist.

Parameter	Min	Typ	Max	Unit
V _O Output Overvoltage	115	/	170	%I _{O,max}

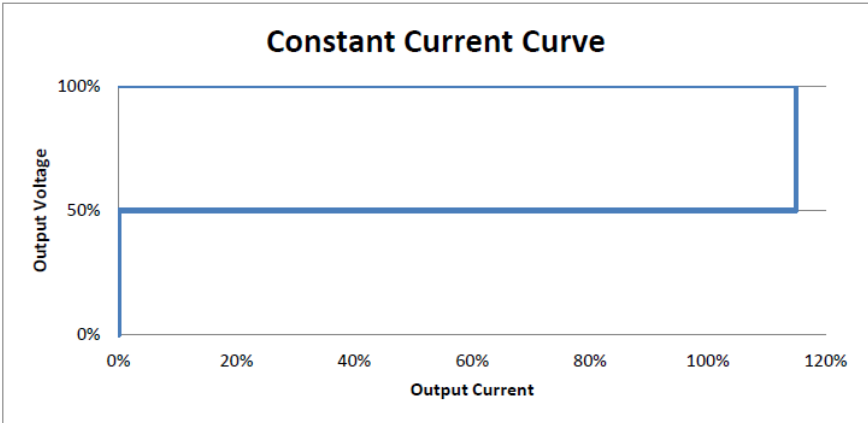

ELECTRICAL SPECIFICATIONS

Protection Function Specifications

Short Circuit Protection (SCP)

The CNS650-M power supplies will withstand a continuous short circuit with no permanent damage, applied to its main output during start-up or while running. A short circuit is defined as an impedance on Vo of 0.1 ohms or less.

When the main output is shorted, the output will go to “hiccup mode”. Recovery will be automatic when the short is removed.

The 5V Standby will remain On while the 12V Fan Output is Off. A Short Circuit on the 5V Standby will shutdown the entire power supply. The power supply will auto recover once the fault condition cease to exist.

Over Temperature Protection (OTP)

The power supply will be internally protected against over temperature conditions. There will be three over-temperature protection sensing - on the main output, the PFC circuit and on the standby output. When one of the sensing circuits has reached the OTP limit, all outputs, except standby, will shut down and will remain off until the over-temperature condition no longer exists. A suitable hysteresis point between the OTP threshold and the recovery point will be set to ensure there is no frequent on-off cycling of the outputs. The temperature recovery point will be set well-within the operating temperature range. Upon reaching the temperature recovery point, all outputs will auto-recover.

MECHANICAL SPECIFICATIONS

Mechanical Outlines (“-MU” Suffix for U-Base Construction / 12V, 24V and 48V. Unit: mm)

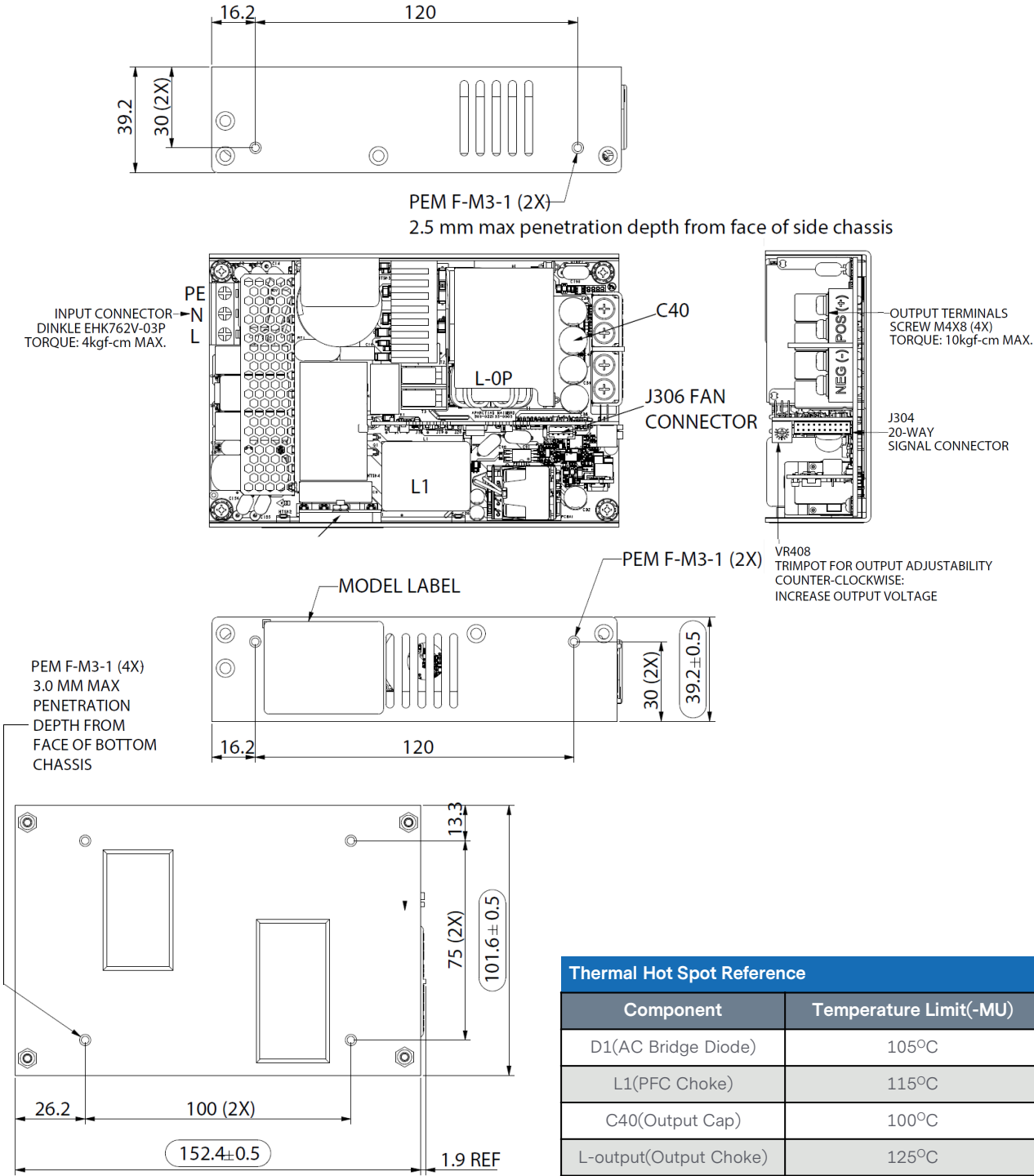

Thermal Hot Spot Reference	
Component	Temperature Limit(-MU)
D1(AC Bridge Diode)	105°C
L1(PFC Choke)	115°C
C40(Output Cap)	100°C
L-output(Output Choke)	125°C

Do not exceed indicated temperature limits to ensure operation is within the component thermal derating limits. Measure the component temperatures using K type thermocouples.

MECHANICAL SPECIFICATIONS

Mechanical Outlines (“-MF” Suffix for Open-frame Construction / 12V only. Unit: mm)

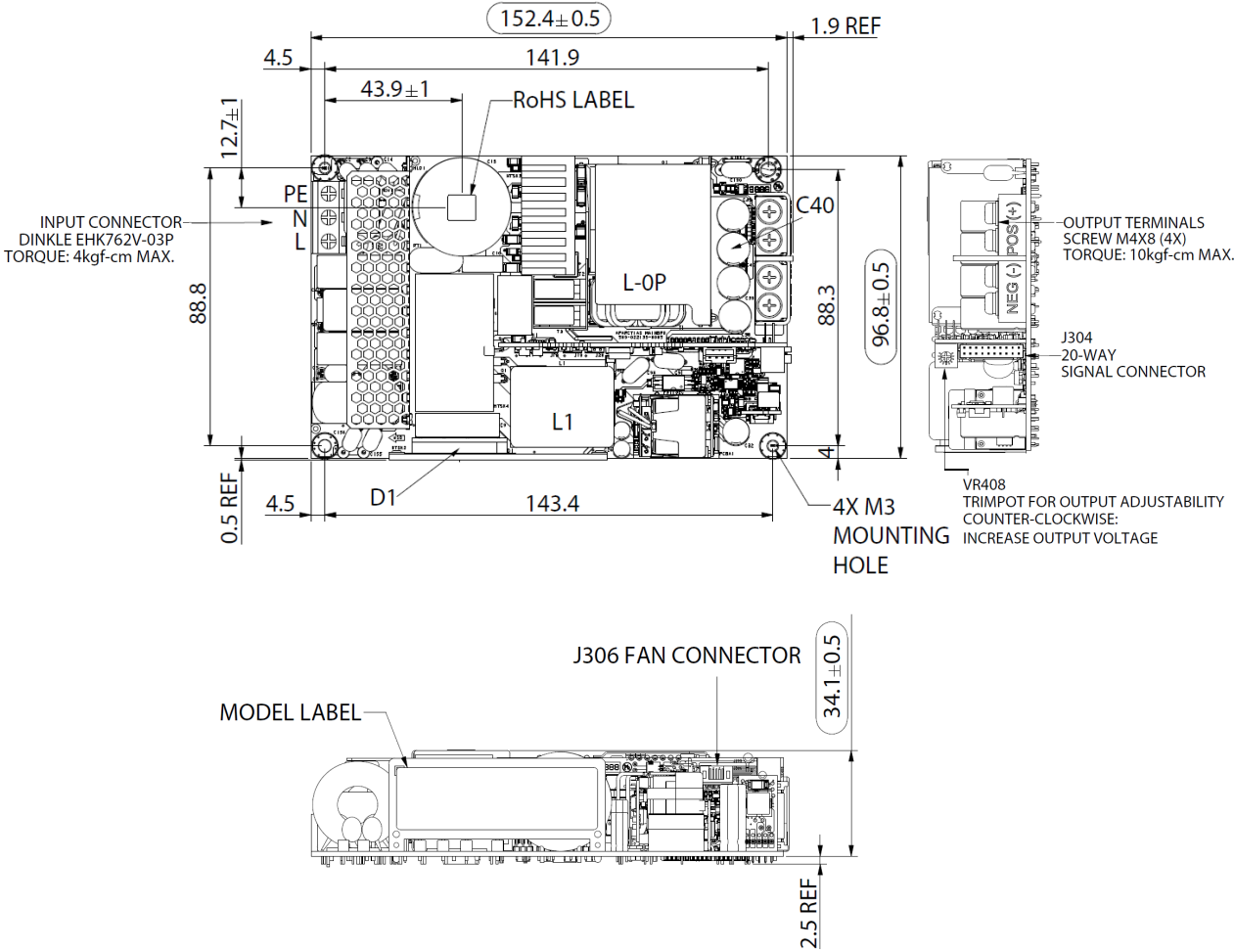

Thermal Hot Spot Reference	
Component	Temperature Limit(-MU)
D1(AC Bridge Diode)	105°C
L1(PFC Choke)	115°C
C40(Output Cap)	100°C
L-output(Output Choke)	125°C

Do not exceed indicated temperature limits to ensure operation is within the component thermal derating limits. Measure the component temperatures using K type thermocouples.

MECHANICAL SPECIFICATIONS

Mechanical Outlines (“-ME” Suffix for End-fan Construction / 12V only. Unit: mm)

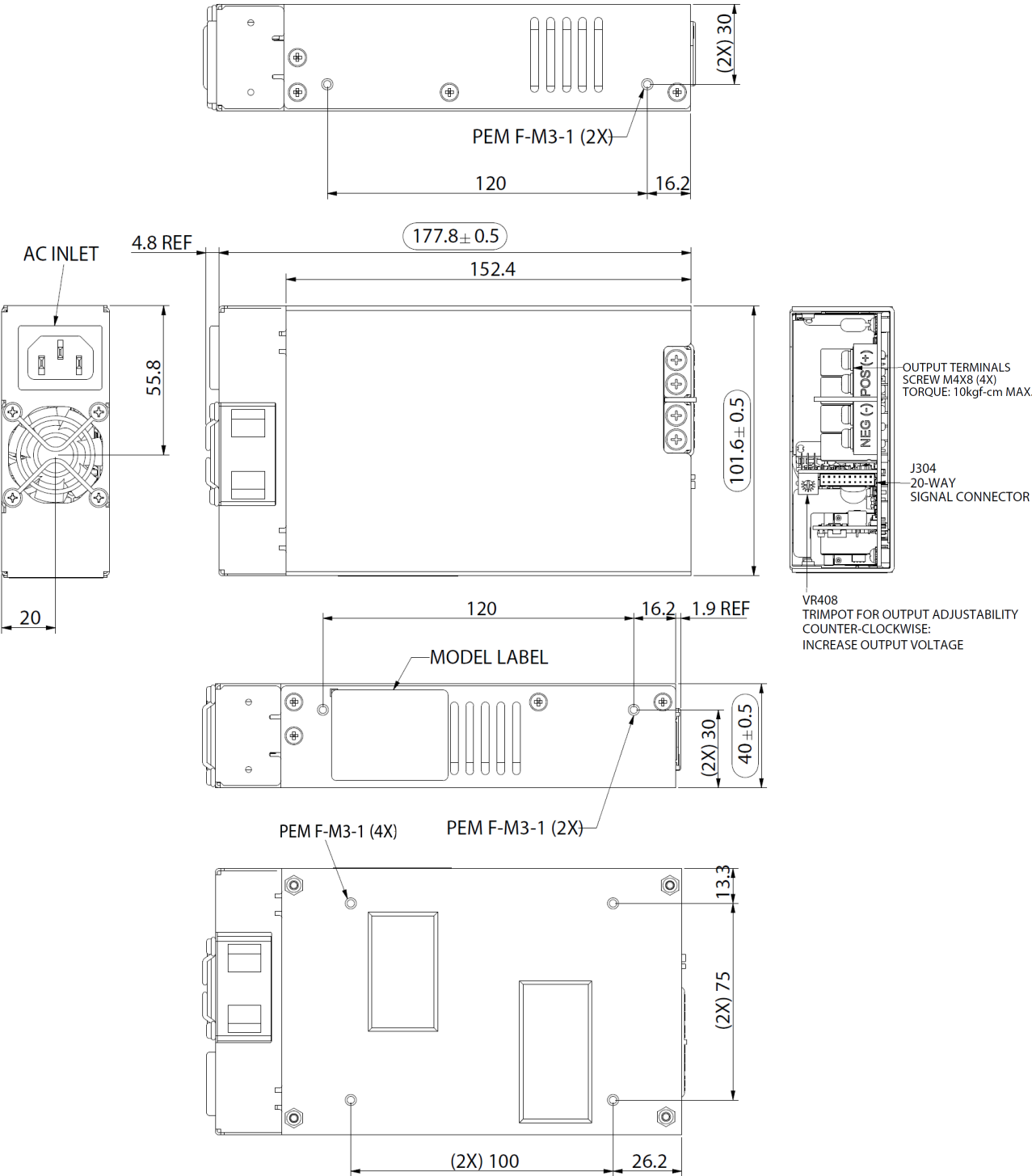

MECHANICAL SPECIFICATIONS

Connector Definitions

AC Input Connector(“MU”, “MF” suffix)

- TB 1 – PE
- TB 2 – Neutral
- TB 3 – Line

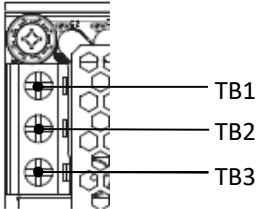

AC Input Connector(“ME” suffix)

IEC 60320 C14 (Male)

DC Output Connector

- BAR1 – -Vout
- BAR2 – -Vout
- BAR3 – +Vout
- BAR4 – +Vout

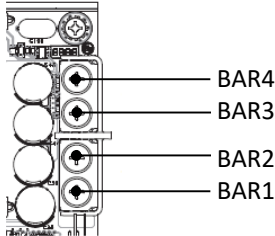

J306 – Fan Header

- F1 – 12VFAN
- F2 – FAN_RTN
- F3 – FAN_PWM1
- F4 – FAN_TACH1



J304 - Signal Output Connector

- | | |
|----------------------|---------------------|
| S1 – 5VSB | S11 – FAN_RTN |
| S2 – 5VSB | S12 – VIN_GOOD |
| S3 – 5VSB_GND | S13 – FAN_PWM1 |
| S4 – SCL | S14 – PWOK |
| S5 – A0 | S15 – FAN_TACH1 |
| S6 – SDA | S16 – FAN_OVERRIDE |
| S7 – I_SHARE | S17 – FAN_FAIL |
| S8 – SYS_GND | S18 – FAN_FAULT_EN |
| S9 – 12VFAN | S19 – REMOTE_SENSE+ |
| S10 – REMOTE INHIBIT | S20 – REMOTE_SENSE- |

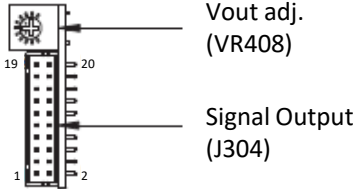

MECHANICAL SPECIFICATIONS

Power / Signal Mating Connectors and Pin Types

Table 4. Mating Connectors for CNS650-M Series		
Reference	Power Supply Side	Mating Connector or Equivalent
AC Input Connector(-MU and -MF Suffix)	Dinkle EHK762V-03P Max Torque: 4kgf-cm	Recommended Wire Size: AWG #22 to #14
AC Input Connector(-ME Suffix)	IEC 60320 C14 (Male)	IEC Cord C13 (Female)
Output Connector	Output Terminal Screw: M4X8 (4X) Max Torque: 10kgf-cm	Molex 19099-0032 or 19141-0063 for AWG #16 to #14 Molex 19099-0048 or 19141-0083 for AWG #12 to #10
Signal Connector(J304)	CviLux: CI0120P1HD0-LF Landwin: 2052P20008T	CviLux: CI0120SD000 (housing) CI01TD21PE0 (contact pins) Landwin: 2050S2000 (housing) 2053T021V (contact pins) JST: PHDR-20VS (housing) SPHD-001T-P0.5 (contact pins)
Fan Connector(J306)	CviLux: CI0104P1HK0-LF Landwin: 2003P0401V	CviLux: CI0104S0000 (housing) CviLux: CI01T01MPP0 (contact pins) Landwin: 2001S0400 (housing) Landwin: 2005T011R (contact pins)

MECHANICAL SPECIFICATIONS

Weight

The CNS650-MU series weigh 800g/1764lbs.

The CNS650-MF series weigh 650g/1433lbs.

The CNS650-ME series weigh 1000g/2205lbs.

ENVIRONMENTAL SPECIFICATIONS

EMC Immunity

CNS650-M series power supply is designed to meet the following EMC immunity specifications.

Table 5. Environmental Specifications	
Document	Description
FCC 47CFR 15 Subpart B / CISPR 22/ EN55032, Class B	Conducted and Radiated (tested with Cover) EMI Limits.
EN61000-3-2	Harmonic Current Emissions, 230Vac with full load, ClassA.
EN61000-3-3	Voltage Fluctuations and Flicker Measurements.
IEC/EN 61000-4-2	Electromagnetic Compatibility (EMC) - Testing and measurement techniques – Electrostatic discharge immunity test. +/-15KV air, +/-8KV contact discharge, performance Criteria A.
IEC/EN 61000-4-3	Electromagnetic Compatibility (EMC) - Testing and measurement techniques, Radiated, radio-frequency, 10V/m electromagnetic field immunity test, Criteria A.
IEC/EN 61000-4-4	Electromagnetic Compatibility (EMC) - Testing and measurement techniques, Electrical Fast Transient/Burst Immunity Test. ± 2 KV injected on Line, Neutral and PE for 1minute minimum. Performance Criteria A.
IEC/EN 61000-4-5	Electromagnetic Compatibility (EMC) - Testing and measurement techniques, Surge Immunity – Level 3: ± 2 KV common mode and ± 1 KV differential mode for AC ports, Performance criteria A; Tested to Level 4 with Performance Criteria C.
IEC/EN 61000-4-6	Electromagnetic Compatibility (EMC) - Testing and measurement techniques, Conducted Disturbance Susceptibility – 0.15-80MHz at 3V 1kHz sine wave, performance criteria A.
IEC/EN 61000-4-8	Electromagnetic Compatibility (EMC) - Testing and measurement techniques, Power Frequency Magnetic Field Immunity – 30A/m 50Hz Strength with 60sec performance criteria A.
IEC/EN 61000-4-11	Electromagnetic Compatibility (EMC) - Testing and measurement techniques : Voltage Dips and Interruptions: 30% reduction for 500ms, Criteria A; 60% reduction for 100mS, Criteria B; >95% reduction for 10mS, Criteria A; >95% reduction for 5000mS, Criteria B.
EN55024	Information Technology Equipment - Immunity Characteristics - Limits and methods of measurement.
EN 60601-1-2:2014	Medical Electrical Equipment - General requirements for Safety.

ENVIRONMENTAL SPECIFICATIONS

Safety Certifications

The CNS650-M series power supply is intended for inclusion in other equipment and the installer must ensure that it is in compliance with all the requirements of the end application. This product is only for inclusion by professional installers within other equipment and must not be operated as a stand alone product.

Table 6. Safety Certifications for CNS650-M Series Power Supply System		
Standard	File #	Description
UL/CSA	E186249-A6009-CB-1	IEC 62368-1:2014 (Second Edition), EN 62368-1:2014+A11:2017
	E186249-A6009-UL-X10	UL 62368-1, 2nd Ed, 2014-12-01, CAN/CSA C22.2 No. 62368-1-14, 2nd Ed
	E186249-A310-CB-2	IEC 60950-1:2005 (Second Edition) +Am1:2009+Am2:2013, EN 60950-1:2006 + A1:2010 + A11:2009 + A12:2011 +A2:2013
TUV	B16051389002676	EN 60601-1:2006/A1:2013
CE	19349	2014/35/EU (LVD); 2011/65/EU (RoHS); EN 60601-1-2:2014
CB	DK-50917-A2-UL DK-77275-M1-UL SG-MD-00582M2	IEC 62368-1(ed.2), IEC 62368-1(ed.2);am1, IEC 62368-1(ed.2);am2 IEC 62368-1:2014 IEC 60601-1(ed.3);am1
CCC	C-00401-Z1604QD-01982	China Requirements GB4943.1-2011; GB9254-2008; GB17625.1-2012
DEMKO	D-06185	EN 62368-1:2014

ENVIRONMENTAL SPECIFICATIONS

EMI Emissions

The CNS650-M series have been designed to comply with the Class B limits per requirements of EN55032 (FCC Part 15) and CISPR 22 (EN55032) for emissions. The unit is tested with Class I input (PE connected) at 650W full load using resistive load with airflow.

Conducted Emissions

The CNS650-M power supplies have internal EMI filters to ensure the power supply's conducted EMI levels comply with EN55022 (FCC Part 15) and EN55022 (CISPR 22) Class B limits. Conducted noise can appear as both differential mode and common mode noise currents. Differential mode noise is measured between the two input lines, with the major components occurring at the supply fundamental switching frequency and its harmonics. Common mode noise, a contributor to both radiated emissions and input conducted emissions, is measured between the input lines and system ground and can be broadband in nature.

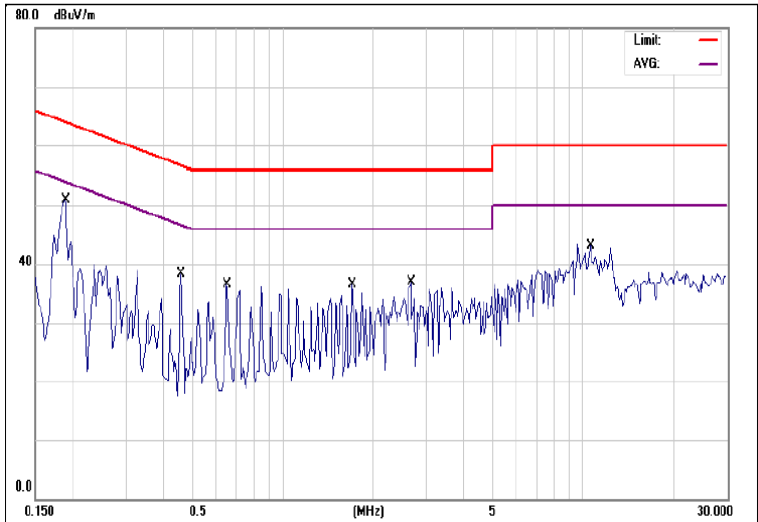

Sample of EN55022 Conducted Emission. Measured at 120Vac input; 650 W Load; Class I Input (PE connected)

Note: Red Line refers to Advanced Energy Quasi Peak margin, which is 6dB below the CISPR international limit. Purple Line refers to Advanced Energy margin, which is 6dB below the CISPR international limit.

Conducted EMI emissions specifications of the CNS650-M series:

Parameter	Model	Symbol	Min	Typ	Max	Unit
FCC Part 15, Class B	All	Margin	-	-	6	dB
CISPR 22 (EN55022) Class B	All	Margin	-	-	6	dB

Radiated Emissions

Unlike conducted EMI, radiated EMI performance in a system environment may differ drastically from that in a stand-alone power supply. The shielding effect provided by the system enclosure may bring the EMI level from Class A to Class B. It is thus recommended that radiated EMI be evaluated in a system environment. The applicable standard is EN55022 Class A (FCC Part 15). Testing ac-dc converters as a stand-alone component to the exact requirements of EN55022 can be difficult, because the standard calls for 1m leads to be attached to the input and outputs and aligned such as to maximize the disturbance. In such a set-up, it is possible to form a perfect dipole antenna that very few ac-dc converters could pass. However, the standard also states that 'an attempt should be made to maximize the disturbance consistent with the typical application by varying the configuration of the test sample'.

ENVIRONMENTAL SPECIFICATIONS

Operating Temperature

The CNS650-M series power supplies can start at -40°C and operate within stated specifications at an ambient temperature from -20°C to 80°C with derating.

Forced Air Cooling

The CNS653-ME power supply includes internal cooling fan as part of the power supply assembly to provide forced air-cooling to maintain and control temperature of devices and ambient temperature in the power supply to appropriate levels. The standard direction of airflow is from the AC connector end to the DC connector end of the power supply.

The cooling fan is a variable speed fan. In standby mode power supply fan will operate at minimum speed to maintain component reliability at all load, line and ambient conditions. When 12V output is enabled, power supply fan will operate at minimum achievable fan speed. Power supply fan speed control algorithms will vary the speed so that the critical component temperatures do not exceed safe operating levels. Fan will be powered from voltage source inside the power supply.

Fan Noise vs. Output Load Curves

CNS653-ME(End Fan) typical audible noise level vs. Output Load at 90Vac, 30°C Ambient.

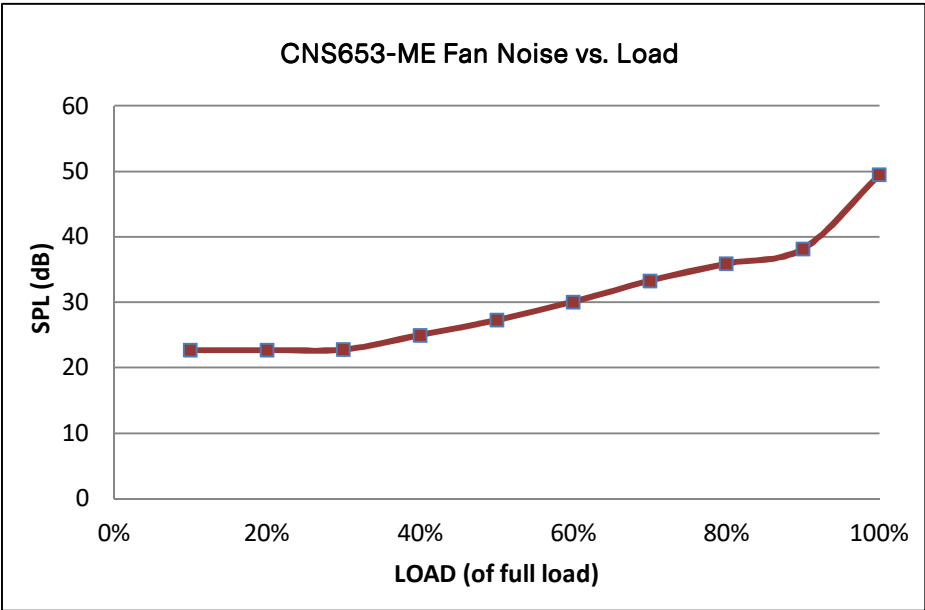

ENVIRONMENTAL SPECIFICATIONS

Power Derating Curves

CNS650-M series total output power will be derated according to the curve shown below. All models can provide derated output power from 50°C up to 80°C ambient temperature max.

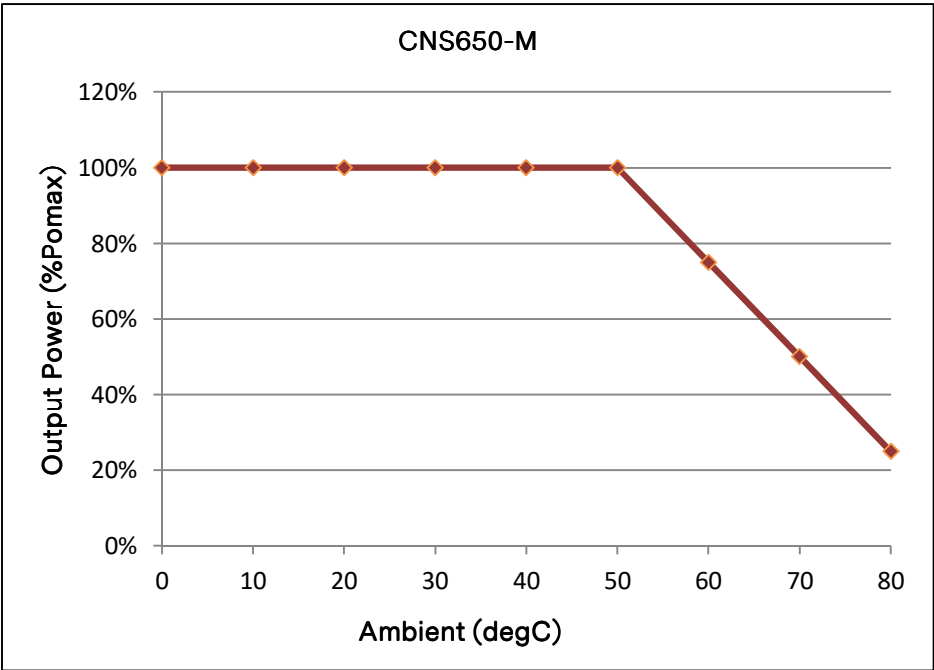

Estimated Service Life

CNS650-M estimated useful life is based on C40 case temperature.

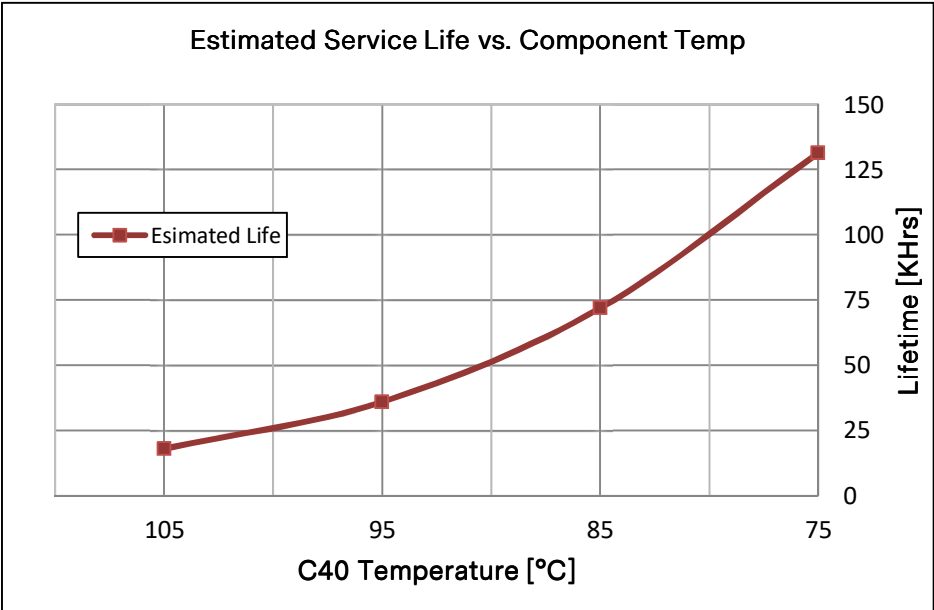

ENVIRONMENTAL SPECIFICATIONS

Storage and Shipping Temperature / Humidity

The CNS650-M series power supplies can be stored or shipped at temperatures from -40 °C to +85 °C and relative humidity from 5% to 95% non-condensing.

Humidity

Operating: Power supply will be designed to operate with no degradation of performance while operating in range of 20% RH to 95%RH non-condensing.

Non-Operating: Power supply will be designed to operate with no degradation of performance while operating in range of 10%RH-95%RH non-condensing.

Vibration

The CNS650-M series power supplies will pass the following vibration specifications:

Acceleration	1	gRMS
Frequency Range	9-200	Hz
Duration	30	mins
Direction	Rotating each axis on vertical vibration	
PSD Profile	FREQ	SLOPE
	5 Hz	dB/oct
	20Hz	PSD
	200 Hz	g²/Hz
		0.001 g ² /Hz
		0.010 g ² /Hz
		0.010 g ² /Hz

Shock

The CNS650-M power supply will pass the following vibration specifications:

Acceleration	10	G
Duration	18	msec
Pulse	Half-Sine	
No. of Shock	3 shock on each of 6 faces	

POWER AND CONTROL SIGNAL DESCRIPTIONS

AC Input Connector

This connector supplies the AC Mains to the CNS650-M power supplies.

- TB 1 - Earth Ground
- TB 2 - Neutral
- TB 3 - Line

Output Connector

This connector supplies the Output Voltage Mains.

- +Vout – Output Positive
- Vout – Output Negative

Fan Output Connector for -MU, -MF suffix

12VFAN, FAN_RTN– (pins F1, F2)

12VFAN is red wire, FAN_RTN is black wire. Both are for the fan input.

FAN_PWM1– (pins F3)

Fan PWM signal is yellow wire, it controls fan speed depending on output duty cycle. The external fan to be connected would need a PWM input pin for speed control.

FAN_TACH1– (pins F4)

Fan tachometer signal is blue wire, it is connected to tacho pin of the external fan, which used for fan speed RPM reporting and fault detection. For correct reporting and fault detection, the pulse period per revolution of the external fan to be used should be:

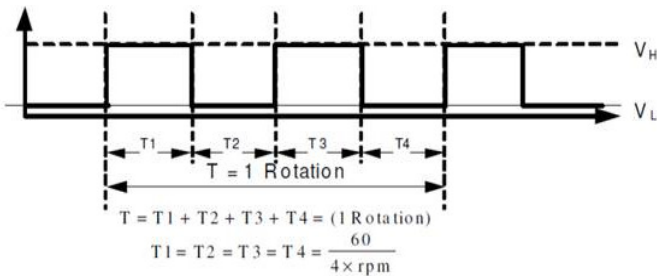

POWER AND CONTROL SIGNAL DESCRIPTIONS

Output Connector - Control Signals

The CNS650-M series contain a 20 pins control signal header providing an analogue control interface, standby power and I2C interface signal connections.

12VFAN, FAN_RTN, FAN_PWM1, FAN_TACH1, FAN_FAULT_EN – (pins S9, S11, S13, S15, S18)

These signals are for fan application. 12VFAN, and FAN_RTN are for the fan input. FAN_PWM1 controls the fan speed. Below tables show the voltage levels:

FAN_TACH1	Symbol	Min	Typ	Max	Units
High Level Input Voltage	Vin	-	3.3	-	V
Low Level Input Voltage	Vin	-	0	-	V

FAN_FAIL	Symbol	Min	Typ	Max	Units
High Level Input Voltage	Vin	-	3.3	-	V
Low Level Input Voltage	Vin	-	0	-	V

FAN_PWM1	Symbol	Min	Typ	Max	Units	Notes and Conditions
High Level Input Voltage	Vin	-	3.3	-	V	Control the FAN speed
Low Level Input Voltage	Vin	-	0	-	V	

FAN_OVERRIDE – (pins S16)

Analog input signal used to override the fan PWM duty. The input range is 1-3.3V, 1V is equivalent to 0% duty and 3.3V is equivalent to 100% duty override setting. It can only override the duty if it is greater than the PSU internal fan control algorithm target duty.

FAN_OVERRIDE	Symbol	Min	Typ	Max	Units
High Level Input Voltage	Vin	-	3.3	-	V
Low Level Input Voltage	Vin	-	1	-	V

FAN_FAULT_EN – (pins S18)

This is an output signal that asserts high if a fan fault is detected. Fan fault will be triggered if the PRM detected from FAN_TACH1 is less than 1000RPM in 10 seconds.

FAN_FAULT_EN	Symbol	Min	Typ	Max	Units	Notes and Conditions
High Level Input Voltage	Vin	2.3	-	-	V	Disabled
Low Level Input Voltage	Vin	-	-	1.35	V	Enabled

POWER AND CONTROL SIGNAL DESCRIPTIONS

REMOTE_SENSE+, REMOTE_SENSE- – (pins S19, S20)

The main output of the CNS650-M series is equipped with a Remote Sensing capability that will compensate for a power path drop around 0.5V. This feature is implemented by connecting the Main Output Remote Sense Positive (pin S19) and the Main Output Remote Sense Return (pin S20) to the positive and negative rails of the main output, respectively, at a location that is near to the load. Care should be taken in the routing of the sense lines as any noise sources or additional filtering components introduced into the voltage rail may affect the stability of the power supply. The CNS650-M will operate appropriately without the sense lines connected; however it is recommended that the sense lines be connected directly to the main output terminals if remote sensing is not required. This remote sense circuit will not raise the power supply's output voltage to the OVP trip level. Main Output Remote Sense has no effect on the Standby Output (Vsb).

12V Main output and Standby output return lines are connected together inside PSU and connected to PSU chassis directly. It is recommended to connect 12V return to system chassis on end system application for better common mode noise.

5VSB, 5VSB_RTN – (pins S1-S2, S3)

The CNS650-M series provide a regulated 5V and 1A auxiliary output voltage at free air cooling, 2A at forced air. The Standby Output (Vsb) voltage is available whenever a valid AC input voltage is applied to the unit. The Standby Output is independently short circuit protected and is referenced to the Standby Output Return pins (S3).

REMOTE INHIBIT – (pin S10)

This pin inhibits the power supply main output. This pin is pulled up 3.3V with a R376 = 10KOhm resistor. This pin is an active low input and the input voltage shows below:

Remote INHIBIT	Symbol	Min	Typ	Max	Units	Notes and Conditions
High Level Input Voltage	Vin	2.3	-	-	V	Remote IHIBIT guarantee high sate
Low Level Input Voltage	Vin	-	-	1.35	V	Remote IHIBIT guarantee low sate

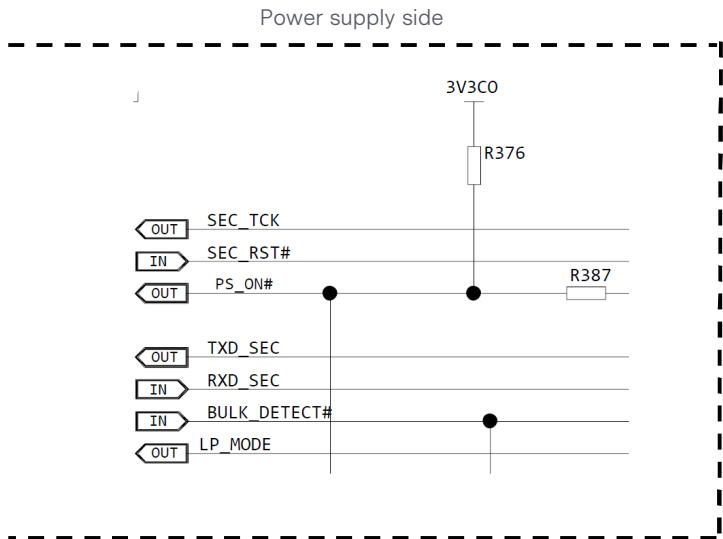

POWER AND CONTROL SIGNAL DESCRIPTIONS

VIN_GOOD – (pin S12)

Signal used to indicate the presence of AC input to the power supply. A logic level HIGH will indicate that the AC input to the power supply is within the operating range while a logic level LOW will indicate that AC has been lost. This is an open collector/drain output. This pin is pulled high by a R426 = 10Kohm resistor connected to 3.3V inside the power supply. It is recommended that this pin be connected to a 100pF decoupling capacitor and pulled down by a 100kohm resistor.

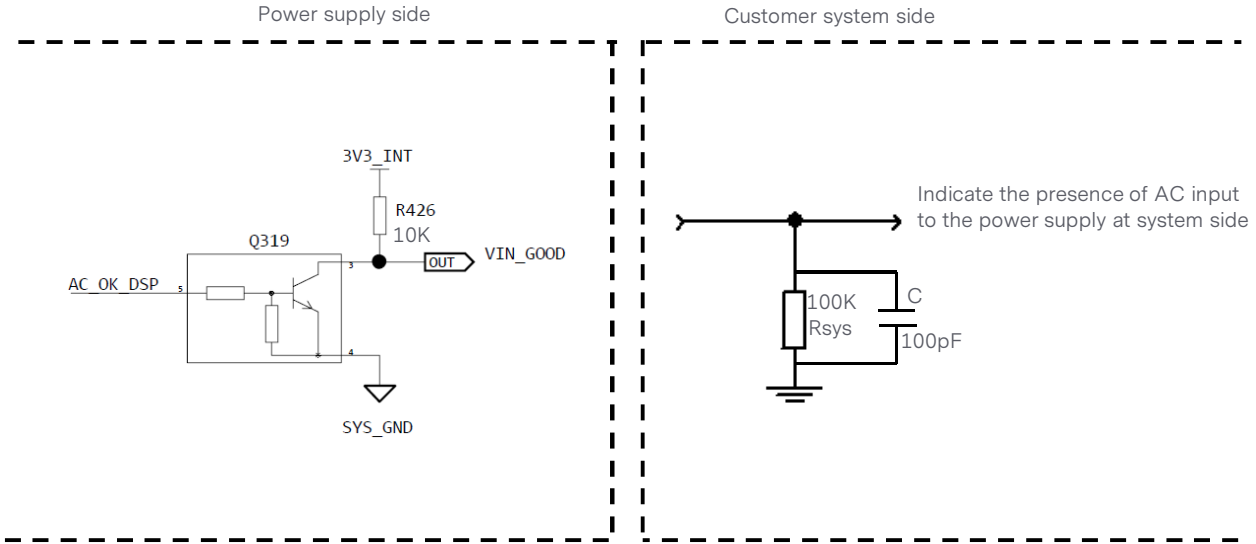

PWOK – (pin S14)

Signal used to indicate that main output voltage is within regulation range. The Output Power OK signal will be driven HIGH when the output voltage is valid and will be driven LOW when the output falls below the under-voltage threshold. This signal also gives an advance warning when there is an impending power loss due to loss of AC input or system shutdown request.

This is an open collector/drain output. This pin is pulled high by a R428 = 10Kohm resistor connected to 3.3V inside the power supply. It is recommended that this pin be connected to a 100pF decoupling capacitor and pulled down by a 100kohm resistor.

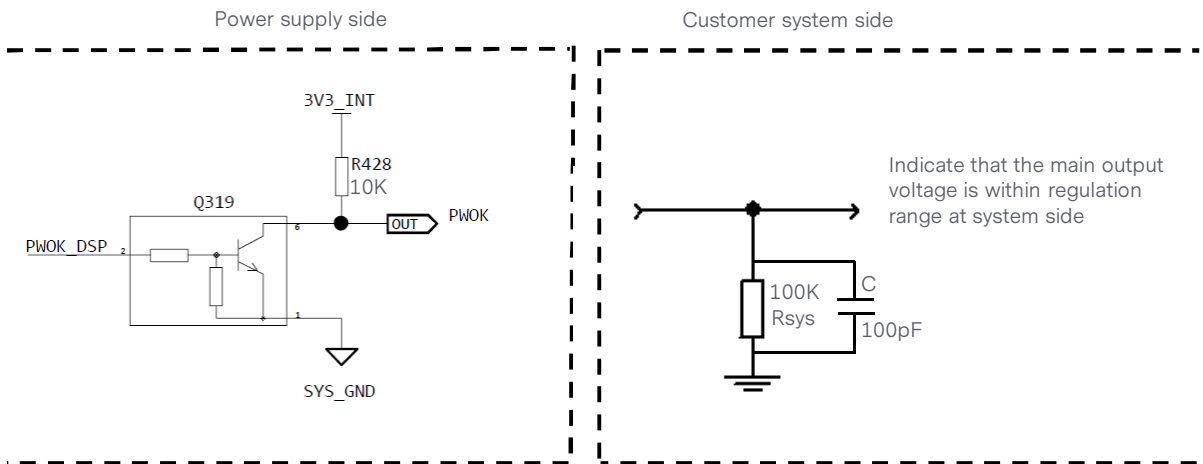

POWER AND CONTROL SIGNAL DESCRIPTIONS

I_SHARE – (pin S7)

The CNS650-M series support active current sharing through a single wire connection between the power supplies. This input/output signal pin just allows two power supplies to share the main output load current to increase the overall power capability or to operate the units in a N+N configuration for redundancy purpose.

The voltage of this signal will be a linear slope from no load to full load. If the current share is 0%, the current share voltage is 0V. If the current share is 50%, the current share voltage is 4V. If the current share is 100%, the current share voltage is 8V.

SCL, SDA and SYS_GND – (pins S4, S6 and S8)

Please refer to "Field Replaceable Unit" section.

A0 – (pin S5)

Please refer to "Field Replaceable Unit" section.

COMMUNICATION BUS DESCRIPTIONS

I²C Bus Signals

The CNS650-M power supply contains enhanced monitoring and control functions implemented via the I²C bus. The CNS650-M I²C functionality (PMBus™ and FRU data) can be accessed via the output connector control signals. The communication bus is powered either by the internal 3.3V supply or from an external power source connected to the standby output (i.e. accessing an unpowered power supply as long as the standby output of another power supply connected in parallel is on).

If units are connected in parallel or in redundant mode, the standby outputs must be connected together in the system. Otherwise, the I²C bus will not work properly when a unit is inserted into the system without the AC source connected.

Note: PMBus™ functionality can be accessed only when the PSU is powered-up. Guaranteed communication I²C speed is 100KHz.

SDA, SCL (I²C Data and Clock Signals) – (pin 6, 4)

I²C serial data and clock bus - these pins are internally pulled up to internal 3.3V supply with a 100K resistor. These pins are recommended to be pulled-up in the system by a 2.2K ohm resistor to the Standby Output.

A0 (I²C Address BIT 0, BIT1 Signals) – (pin 5)

These two input pins are the address lines A0 and A1 to indicate the slot position the power supply occupies in the power bay and define the power supply addresses for FRU data and PMBus™ data communication. This allows the system to assign different addresses for each power supply. During I²C communication between system and power supplies, the system will be the master and power supplies will be slave.

They are internally pulled up to internal 3.3V supply with a 10K resistor.

I²C Bus Communication Interval

The interval between two consecutive I²C communications to the power supply should be at least 50ms to ensure proper monitoring functionality.

I²C Bus Signal Integrity

The noise on the I²C bus (SDA, SCL lines) due to the power supply will be less than 500mV peak-to-peak. This noise measurement should be made with an oscilloscope bandwidth limited to 100MHz. Measurements should be made at the power supply output connector with 3.2K ohm resistors pulled up to standby output and 20pF ceramic capacitors to standby output return.

The noise on the address lines A0 and A1 will be less than 100mV peak-to-peak. This noise measurement should be made at the power supply output connector.

COMMUNICATION BUS DESCRIPTIONS

I²C Bus Internal Implementation, Pull-ups and Bus Capacitances

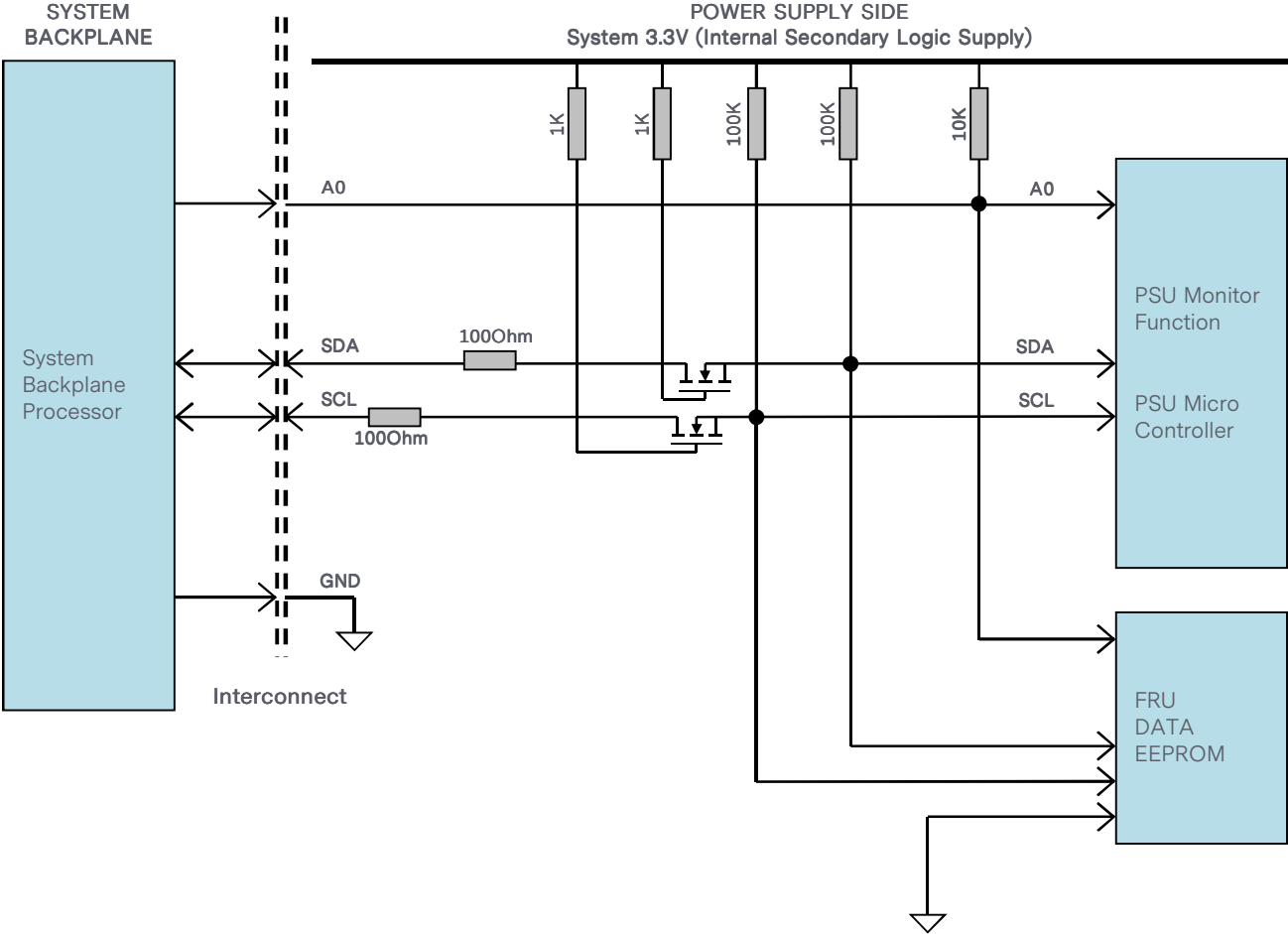

I²C Bus - Recommended external pull-ups

Electrical and interface specifications of I²C signals (referenced to standby output return pin, unless otherwise indicated):

Parameter	Condition	Symbol	Min	Typ	Max	Unit
SDA, SCL Internal Pull-up Resistor		R _{int}	-	100	-	Kohm
SDA, SCL Internal Bus Capacitance		C _{int}	-	0	-	pF
Recommended External Pull-up Resistor	1 to 2 PSU	R _{ext}	-	2.2	-	Kohm

COMMUNICATION BUS DESCRIPTIONS

Logic Levels

CNS650-M series power supply I²C Communication Bus will respond to logic levels as per below:

Logic High: 3.3V Nominal (Specs is 2.1V to 5.5V)**

Logic Low: 500mV nominal (Specs is 800mV max)**

**Note: Artesyn 73-769-001 I²C adapter is used.

Timings

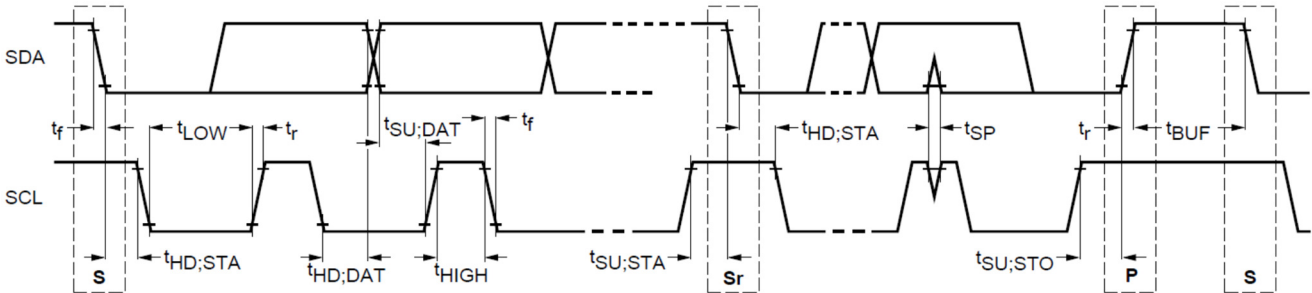

Parameter	Symbol	Standard-Mode Specs		Actual Measured		Unit
		Min	Max			
SCL Clock Frequency	f_{SCL}	0	100	98.0		KHz
Hold time (repeated) START condition	$t_{HD;STA}$	4.0	-	4.7		mS
LOW period of SCL clock	t_{LOW}	4.7	-	15.2		mS
HIGH period of SCL clock	t_{HIGH}	4.0	-	4.0		mS
Setup time for repeated START condition	$t_{SU;STA}$	4.7	-	4.95		mS
Data hold time	$t_{HD;DAT}$	0	3.45	0.26		mS
Data setup time	$t_{SU;DAT}$	250	-	3920		nS
Rise time	t_r	-	1000	SCL = 800	SDA = 940	nS
Fall time	t_f	-	300	SCL = 120	SDA = 120	nS
Setup time for STOP condition	$t_{SU;STO}$	4.0	-	6.36		mS
Bus free time between a STOP and START condition	t_{BUF}	4.7	-	100***		mS

*** Note Artesyn 73-769-001 I²C adapter (USB-to-I²C) and Universal PMBus™ GUI software was used.

COMMUNICATION BUS DESCRIPTIONS

Device Addressing

The CNS650-M series will respond to supported commands on the I²C bus that are addressed to pin A0 pins of output connector. Address pins are held HIGH by default via pulled up to internal 3.3V supply with a 10K resistor. To set the address as “0”, the corresponding address line should be pulled down to logic ground level. Below tables show the address of the power supply with A0 pin set to either “0” or “1”.

PSU Slot	Slot ID Bits	PMBus™ Address	EEPROM (FRU) Read Address
	A0		
1	0	0xB0	0xB0
2	1	0xB2*	0xB2

Note: * Default PMBus™ address when A0 is left open.

COMMUNICATION BUS DESCRIPTIONS

I²C Clock Synchronization

The CNS650-M power supply might apply clock stretching. An addressed slave power supply may hold the clock line (SCL) low after receiving (or sending) a byte, indicating that it is not yet ready to process more data. The system master that is communicating with the power supply will attempt to raise the clock to transfer the next bit, but must verify that the clock line was actually raised. If the power supply is clock stretching, the clock line will still be low (because the connections are open-drain).

The maximum time out condition for clock stretching for CNS650-M is 100 milliseconds.

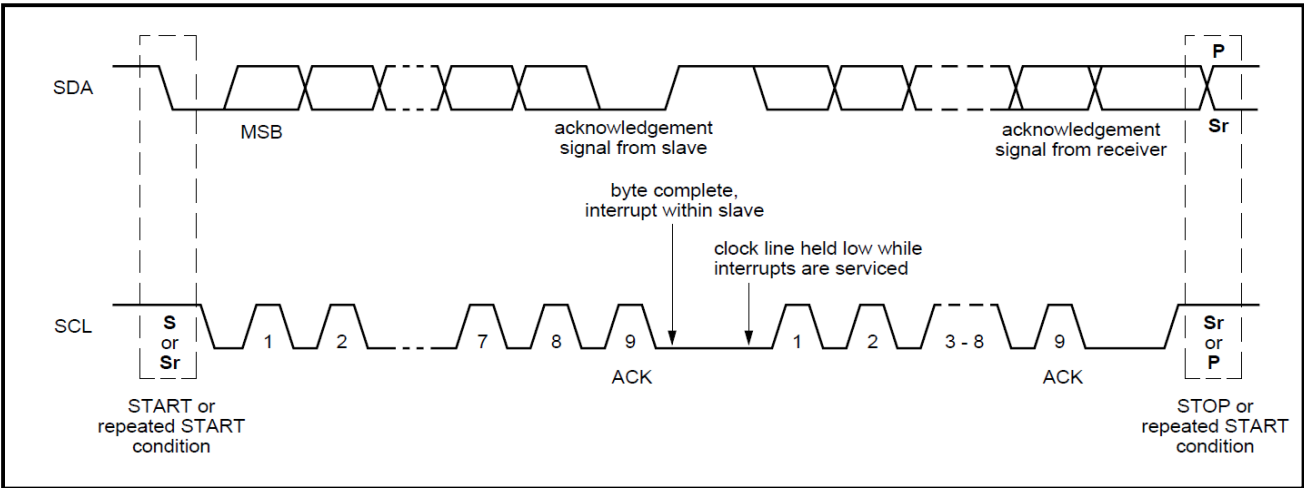

COMMUNICATION BUS DESCRIPTIONS

FRU (EEPROM) Data

The FRU (Field Replaceable Unit) data format is compliant with the Intel IPMI v1.0 specification.

The CNS650-M series uses 1 page of EEPROM for FRU purpose. A page of EEPROM contains up to 256 byte-sized data locations.

Where:	OFFSET	-The OFFSET denotes the address in decimal format of a particular data byte with CNS650-M series EEPROM.
	VALUE	-The VALUE details data written to a particular memory location of the EEPROM.
	DEFINITION	-The contents DEFINITION refers to the definition of a particular data byte.

CNS655-MU FRU (EEPROM) Data:

OFFSET		DEFINITION	SPEC VALUE	
(DEC)	(HEX)	(REMARKS)	(DEC)	(HEX)
COMMON HEADER, 8 BYTES				
0	00	FORMAT VERSION NUMBER (Common header) 7:4 - Reserved, write as 0000b 3:0 - Format version number = 1h for this specification	1	01
1	01	INTERNAL USE AREA OFFSET (Not required, do not reserve)	28	1B
2	02	CHASSIS INFO AREA OFFSET (Not required, do not reserve)	1	01
3	03	BOARD INFO AREA OFFSET (Not required, do not reserve)	0	00
4	04	PRODUCT INFO AREA OFFSET	5	05
5	05	MULTI RECORD AREA OFFSET	13	0D
6	06	PAD (Not required, do not reserve)	0	00
7	07	ZERO CHECK SUM (256 - (Sum of bytes 0 to 6))	NA	NA
CHASSIS INFO AREA(32 BYTES) This area will be filled by the Mfg. Diag. or by the OS if used				
8	08	FORMAT VERSION NUMBER 7:4 - Reserved, write as 0000b 3:0 - Format version number = 1h for this specification	1	01
9	09	CHASSIS INFO AREA LENGTH in multiple of 8 bytes	4	04
10	0A	CHASSIS TYPE (Default value is 0)	0	00
11	0B	CHASSIS PART NUMBER Type/Length CAh (if used) Type = "ASCII+LATIN1" = (11)b Length = 10 Bytes = (001010)b	202	CA
12	0C	CHASSIS PART NUMBER BYTES (Default value is 0)	0	00
13	0D		0	00
14	0E		0	00
15	0F		0	00
16	10		0	00
17	11		0	00
18	12		0	00
19	13		0	00
20	14		0	00
21	15		0	00
22	16	CHASSIS SERIAL NUMBER Type/Length CFH (if used) Type = "ASCII+LATIN1" = (11)b Length = 15 Bytes = (001111)b	207	CF
23	17	CHASSIS SERIAL NUMBER BYTES (Default value is 0)	0	00
24	18		0	00
25	19		0	00
26	1A		0	00
27	1B		0	00
28	1C		0	00
29	1D		0	00
30	1E		0	00
31	1F		0	00

COMMUNICATION BUS DESCRIPTIONS

CNS650-M FRU (EEPROM) Data:

OFFSET		DEFINITION (REMARKS)	SPEC VALUE	
(DEC)	(HEX)		(DEC)	(HEX)
32	1F		0	00
33	20		0	00
34	22		0	00
35	23		0	00
36	24		0	00
37	25		0	00
38	26	End Tag (0C1h if used)	193	C1
39	27	CHKSUM (Zero CHKSUM if used)	161	A1
PRODUCT INFORMATION AREA, 56 BYTES				
40	28	FORMAT VERSION NUMBER (Product Info Area) 7:4 - Reserved, write as 0000b 3:0 - Format Version Number = 1h for this specification	1	01
41	29	PRODUCT INFO AREA LENGTH (In multiples of 8 bytes)	8	08
42	2A	Language (English)	25	19
43	2B	MANUFACTURER NAME TYPE / LENGTH (0C5H) Type "ASCII+LATIN1" 5 Bytes.	199	C7
44	2C	MANUFACTURER'S NAME 5 byte sequence "A" "R" "T" "E" "S" "Y" "N"	65	41
45	2D		82	52
46	2E		84	54
47	2F		69	45
48	30		83	53
49	31		89	59
50	32	78	4E	
51	33	PRODUCT NAME Type/Length (CFH) Type = "ASCII+LATIN1" = (11)b Length = 15 Bytes = (001100)b	207	CF
52	34	Product Name (15 Byte sequence) "C" "N" "S" "6" "5" "5" "-" "M" "U"	67	43
53	35		78	4E
54	36		83	53
55	37		54	36
56	38		53	35
57	39		53	35
58	3A		45	2D
59	3B		77	4D
60	3C		85	55
61	3D		32	20
62	3E		32	20
63	3F		32	20
64	40		32	20
65	41		32	20
66	42		32	20
67	43	PRODUCT NAME Type/Length (CFH) Type = "ASCII+LATIN1" = (11)b Length = 15 Bytes = (001100)b	207	CF
68	44	Product PART/MODEL NUMBER BYTES "C" "N" "S" "6" "5" "5" "-" "M" "U"	67	43
69	45		78	4E
70	46		83	53
71	47		54	36
72	48		53	35
73	49		53	35
74	4A		45	2D
75	4B		77	4D
76	4C		85	55
77	4D		32	20
78	4E		32	20

COMMUNICATION BUS DESCRIPTIONS

CNS650-M FRU (EEPROM) Data:

OFFSET		DEFINITION (REMARKS)	SPEC VALUE	
(DEC)	(HEX)		(DEC)	(HEX)
79	4F		32	20
80	50		32	20
81	51		32	20
82	52		32	20
83	53	PRODUCT VERSION NUMBER Type/Length (C2h) Type = "ASCII+LATIN1" = (11)b Length = 2 bytes = (000010)b	194	C2
84	54	PRODUCT VERSION NUMBER BYTES "A"	65	41
85	55	"A"	65	41
86	56	PRODUCT SERIAL NUMBER Type/Length Type = "ASCII+LATIN1" = (11)b Length = 13 bytes = (001101)b	205	CD
87	57	PRODUCT SERIAL NUMBER BYTES Model ID = L842 "L"	76	4C
88	58	"8"	56	38
89	59	"4"	52	34
90	5A	"2"	50	32
91	5B	MANUFACTURING YEAR AND WEEK CODE	XX	XX
92	5C	Values for these registers shall be dynamically assigned in factory	XX	XX
93	5D	Unique Serial Number	XX	XX
94	5E	Values for these registers shall be dynamically assigned in factory	XX	XX
95	5F		XX	XX
96	60		XX	XX
97	61	MODEL REVISION "A"	65	41
98	62	"A"	65	41
99	63	MANUFACTURING LOCATION "P" In Decimal = 080 In Hex = 50H	80	50
100	64	End Tag	193	C1
101	65	PAD (reserved), Default value is 0.	0	00
102	66		0	00
103	67	ZERO CHECK SUM (256 - (Sum of bytes 40 to 102)) Zero Check Sum :Should follow check sum calculation as per IPMI v1.1 specs	193	C1
Multi Record Area, 88 Bytes				
104	68	Power Supply Record Header Record type = 00 for Power supply	0	00
105	69	End of List /Record Format Version Number	2	02
106	6A	Record Length of Power Supply Record	24	18
107	6B	Record CHECKSUM of Power Supply Record (Zero CHECKSUM) (256-(sum of bytes 109 to 132))	XXX	XX
108	6C	Header CHECKSUM of Power Supply Record Header (Zero CHECKSUM) ((256-(sum of bytes 104 to 107))	XXX	XX
Power Supply Record				
109	6D	Overall Capacity of the Power Supply, 650W = 028AH 2 Bytes Sequence In Decimal = 138, 002	138	8A
110	6E	In Hex = 8AH, 02H	2	02
111	6F	Peak VA, 828W = 033CH 2 Bytes Sequence In Decimal = 060, 003	60	3C
112	70	In Hex = 3CH, 03H	3	03

COMMUNICATION BUS DESCRIPTIONS

CNS650-M FRU (EEPROM) Data:

OFFSET		DEFINITION (REMARKS)	SPEC VALUE	
(DEC)	(HEX)		(DEC)	(HEX)
113	71	Inrush Current, 50A = 32H In Decimal = 050 In Hex = 32H	50	32
114	72	Inrush Interval, 10mS In Decimal = 010 In Hex = 0AH	10	0A
115	73	Low End Input Voltage Range 1(10mV), (90V / 10mV) 9000 = 2328H 2 Bytes Sequence In Decimal = 040, 035 In Hex = 28H, 23H	40	28
116	74		35	23
117	75	High End Input Voltage Range 1(10mV), (264V/10mV) 26400= 6720H 2 Bytes Sequence In Decimal = 032, 103 In Hex = 20H, 67H	32	20
118	76		103	67
119	77	Low End Input Voltage Range 2(10mV) Not Applicable (Autoswitch)	0	00
120	78		0	00
121	79	High End Input Voltage Range 2(10mV) Not Applicable (Autoswitch)	0	00
122	7A		0	00
123	7B	Low End Input Frequency Range, 47Hz = 2FH	47	2F
124	7C	Low End Input Frequency Range, 63Hz = 3FH	63	3F
125	7D	AC Dropout Tolerance in ms, 10mS= 0AH	10	0A
126	7E	Binary Flags, 1 indicates function supported and a 0 not supported. Bits 7-6: RESERVED, WRITE AS 000B Bit 5: PMBus Capable or not BIT = 1 Bit 4: Tachometer Pulses Per Rotation / Predictive Fail Polarity BIT = 0 Bit 3: Hot Swap / Redundancy Support BIT = 0 Bit 2: Auto switch Support BIT = 1 Bit 1: Power Factor Correction Support BIT = 1 Bit 0: Predictive Fail Support BIT = 0	38	26
127	7F	Peak Wattage Capacity 780W = 30CH Bits 11- 0: Peak Capacity in Watts 1800 = 708H 2 Bytes sequence: In Decimal: 012, 003 In Hex: 0CH, 03H	12	0C
128	80		3	03
129	81	Combined Wattage, Not Applicable Byte 1: 000 = 00H Bits 7-4: 0000B Bits 3-0: 0000B Byte 2 and Byte 3: 00H, 00H 3 Bytes Sequence In Decimal = 000, 000, 000 In Hex = 00H, 00H, 00H	0	00
130	82		0	00
131	83		0	00
132	84	Predictive Fail Tachometer Lower Threshold, Not Applicable. Predictive Failure is not Supported.	0	00
12V DC OUTPUT RECORD HEADER				
133	85	Record type = 01 for DC Output Record	1	01
134	86	End of List /Record Format Version Number for 12V DC Output Record	2	02
135	87	Record Length of 12V DC Output Record	13	0D
136	88	Record CHECKSUM of 12V DC Output Record (Zero CHECKSUM)	XXX	XX
137	89	(256-(sum of bytes 138 to 150)) Header CHECKSUM of 12V DC Output Record Header (Zero CHECKSUM) (256-(sum of bytes 133 to 136))	XXX	XX

COMMUNICATION BUS DESCRIPTIONS

CNS650-M FRU (EEPROM) Data:

OFFSET		DEFINITION (REMARKS)	SPEC VALUE	
(DEC)	(HEX)		(DEC)	(HEX)
12V OUTPUT RECORD				
138	8A	Output Information, 001 = 01H Bit 7: Standby Information = 0B Bits 6-4: Reserved, Write as 000B Bits 3-0: Output Number 1 = 001B	1	01
139 140	8B 8C	Nominal Voltage (10mV), (12V / 10mV) 1200 = 04B0H 2 Bytes Sequence In Decimal: 176, 004 In Hex: B0H, 04H	176 4	B0 04
141 142	8D 8E	Maximum Negative Voltage Deviation (10mV), 1380 = 0564H 2 Bytes Sequence In Decimal: 176, 004 In Hex: B0H, 04H	176 4	B0 04
143 144	8F 90	Maximum Positive Voltage Deviation (10mV), 1380 = 0564H 2 Bytes Sequence In Decimal: 236, 004 In Hex: ECH, 04H	236 4	EC 04
145 146	91 92	Ripple and Noise pk-pk (mV), 120 = 0078H 2 Bytes Sequence In Decimal: 120, 000 In Hex: 078H, 00H	120 0	78 00
147 148	93 94	Minimum Current Draw (10mA), 0000 = 0000H 2 Bytes Sequence In Decimal: 000, 000 In Hex: 00H, 00H	0 0	00 00
149 150	95 96	Maximum Current Draw (10mA), 10000 = 2710H 2 Bytes Sequence In Decimal: 040, 021 In Hex: 28H, 15H	40 21	28 15
5VSB OUTPUT RECORD HEADER				
151	97	Record type = 01 for DC Output Record	1	01
152	98	End of List /Record Format Version Number for 5VSB Output Record	2	02
153	99	Record Length of 5VSB Output Record	13	0D
154	9A	Record CHECKSUM of 5VSB Output Record (Zero CHECKSUM) (256-(sum of bytes 156 to 168))	XXX	XX
155	9B	Header CHECKSUM of 5VSB Output Record Header (Zero CHECKSUM) (256-(sum of bytes 151 to 154))	XXX	XX
5VSB OUTPUT RECORD				
156	9C	Output Information, 002 = 02H Bit 7: Standby Information = 1B Bits 6-4: Reserved, Write as 000B Bits 3-0: Output Number 2 = 010B	130	82
157 158	9D 9E	Nominal Voltage (10mV), (5.0V / 10mV) 5000 = 01F4h 2 Bytes Sequence In Decimal: 244, 001 In Hex: F4H, 01h	74 1	4A 01
159 160	9F A0	Maximum Negative Voltage Deviation (10mV), (4.75V/10mV) 475= 01DBh 2 Bytes Sequence In Decimal: 219, 001 In Hex: DBH, 01h	219 1	DB 01

COMMUNICATION BUS DESCRIPTIONS

CNS650-M FRU (EEPROM) Data:

OFFSET		DEFINITION	SPEC VALUE	
(DEC)	(HEX)	(REMARKS)	(DEC)	(HEX)
161	A1	Maximum Positive Voltage Deviation (10mV) , (5.25V/ 10mV) 525 =020Dh 2 Bytes Sequence In Decimal: 013, 002 In Hex: 5AH, 02H	13	0D
162	A2		2	02
163	A3	Ripple and Noise pk-pk (mV) , 50 = 0032H 2 Bytes Sequence In Decimal: 050, 000 In Hex: 32H, 01H	50	32
164	A4		0	00
165	A5	Minimum Current Draw (10mA) , (0.0A / 10mA) 0 = 0000H 2 Bytes Sequence In Decimal: 000, 000 In Hex: 00H, 00H	0	00
166	A6		0	00
167	A7	Maximum Current Draw (10mA) , (2.0A / 10mA) 200 = 00C8H 2 Bytes Sequence In Decimal: 200, 000 In Hex: C8H, 00H	200	C8
168	A8		0	00
OEM RECORD HEADER				
169	A9	Record type = C0H for OEM Record	192	C0
170	AA	End of List /Record Format Version Number for 5Vsb output Record	130	82
171	AB	Record Length of OEM Record	42	2A
172	AC	Record CHECKSUM of OEM Record (Zero CHECKSUM) (256-(sum of bytes 174 to 215))	0	00
173	AD	Header CHECKSUM of OEM Record Header (Zero CHECKSUM) (256-(sum of bytes 169 to 172))	148	94
OEM RECORD				
177	B1	RESERVED	0	00
178	B2	RESERVED	0	00
179	B3	RESERVED	0	00
180	B4	RESERVED	0	00
181	B5	RESERVED	0	00
182	B6	RESERVED	0	00
183	B7	RESERVED	0	00
184	B8	RESERVED	0	00
185	B9	RESERVED	0	00
186	BA	RESERVED	0	00
187	BB	PAD (reserved), Default value is 0.	0	00
188	BC		0	00
189	BD		0	00
190	BE		0	00
191	BF		0	00
192	C0		0	00
193	C1		0	00
194	C2		0	00
195	C3		0	00
196	C4		0	00
197	C5		0	00
198	C6		0	00
199	C7		0	00
200	C8		0	00
201	C9		0	00
202	CA		0	00
203	CB		0	00
204	CC		0	00
205	CD		0	00
206	CE	0	00	
207	CF	0	00	

COMMUNICATION BUS DESCRIPTIONS

CNS650-M FRU (EEPROM) Data:

OFFSET		DEFINITION (REMARKS)	SPEC VALUE	
(DEC)	(HEX)		(DEC)	(HEX)
208	D0		0	00
209	D1		0	00
210	D2		0	00
211	D3		0	00
212	D4		0	00
213	D5		0	00
214	D6		0	00
215	D7		0	00
INTERNAL USE AREA, 40 BYTES				
216	D8	FORMAT VERSION NUMBER 7:4 - Reserved , write as 0000b 3:0 - Format Version Number = 1h for this specification	0	00
217	D9	INTERNAL USE AREA LENGTH in multiple of 8 bytes	0	00
218	DA		0	00
219	DB		0	00
220	DC		0	00
221	DD		0	00
222	DE		0	00
223	DF		0	00
224	E0		0	00
225	E1		0	00
226	E2		0	00
227	E3		0	00
228	E4		0	00
229	E5		0	00
230	E6		0	00
231	E7		0	00
232	E8		0	00
233	E9		0	00
234	EA		0	00
235	EB		0	00
236	EC		0	00
237	ED		0	00
238	EE		0	00
239	EF		0	00
240	F0		0	00
241	F1		0	00
242	F2		0	00
243	F3		0	00
244	F4		0	00
245	F5		0	00
246	F6		0	00
247	F7		0	00
248	F8		0	00
249	F9		0	00
250	FA		0	00
251	FB		0	00
252	FC		0	00
253	FD		0	00
254	FE		0	00
255	FF	Zero CHECKSUM (256-(sum of bytes 216 to 254))	250	FA

PMBus™ SPECIFICATIONS

The CNS650-M series are compliant with the industry standard PMBus™ protocol for monitoring and control of the power supply via the I²C interface port.

CNS650-M Series PMBus™ General Instructions

Equipment Setup

The following is typical I²C communication setup:

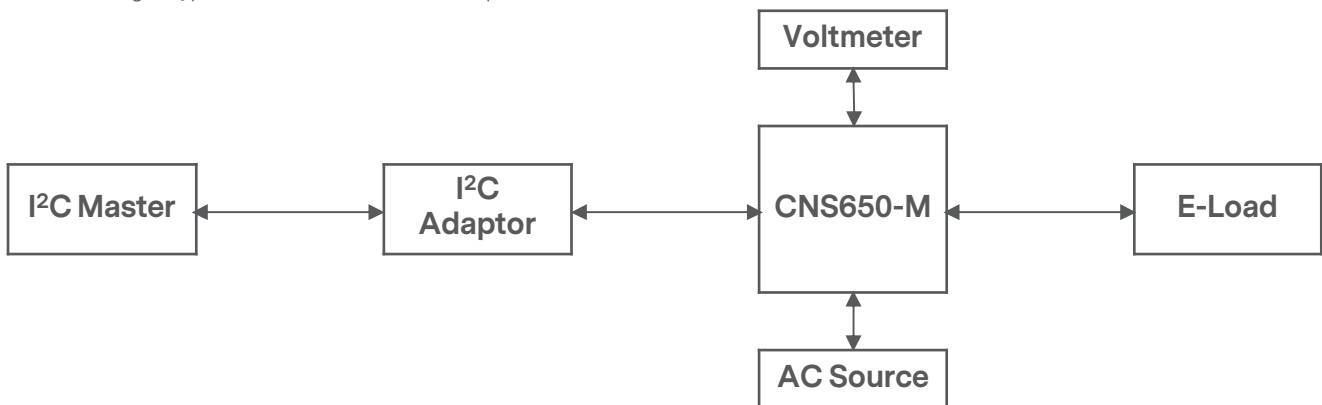

PMBus™ Writing Instructions

When writing to any PMBus™ R/W registers, ALWAYS do the following:

Disable Write Protect (command 10h) by writing any of the following accordingly:

- Levels: 00h - Enable writing to all writeable commands
- 20h - Disables write except 10h, 01h, 00h, 02h and 21h commands
- 40h - Disables write except 10h, 01h, and 00h commands
- 80h - Disable write except 0x00h

To save changes on the USER PMBus™ Table:

Use send byte command: 15h STORE_USER_ALL

To save changes on the DEFAULT PMBus™ Table:

Use send byte command: 11h STORE_DEFAULT_ALL

Wait for 5 seconds, turn-off the PSU, wait for another 5 seconds before turning it on.

PMBus™ SPECIFICATIONS

The CNS653-M Supported PMBus™ Command List:

Command Code	Command Name	Default Value	Access Type	Data Bytes	Data Format	Description
00h	PAGE	00h	R	1	Hex	
01h	OPERATION	80h	R/W	1	Bitmapped	Used to turn the unit ON/OFF in conjunction with the input INH_EN pin.
	b7:6	10				01 – Soft Turn OFF (With Sequencing) 10 - PSU ON
	b5:4	00				
	b3:2	00				
	b1:0	00				Reserved
02h	ON_OFF_CONFIG	1Eh	R	1	Bitmapped	Configures the combination of INH_EN pin and serial communication commands needed to turn the unit ON/OFF.
	b7:5	000				Reserved
	b4 – Enable INH_EN pin and Serial communication control.	1				0 – Unit powers up any time power is present regardless of the state of INH_EN pin. 1 – Unit powers up as dictated by INH_EN pin and OPERATION command (b3:0).
	b3 – Serial communication Control	1				0 – Unit Ignores ON/OFF portion of the OPERATION command. 1 – Enables Serial communication ON/OFF portion of OPERATION command. Requires INH_EN pin to be asserted for the unit to start and energize the output.
	b2 – Sets how the unit responds to INH_EN pin	1				0 – Unit ignores INH_EN pin. (ON/OFF controlled by OPERATION command). 1 – Unit requires INH_EN pin to be asserted to start the unit.
	b1 – INH_EN pin polarity	1				0 – Active Low (Pull Low to start the unit). 1 – Active high (Pull high to start the unit).
	b0 – INH_ENL pin action	0				0 – Use programmed turn ON/OFF delay. 1 – Turn OFF the output and stop transferring energy to the output as fast as possible.
03h	CLEAR_FAULTS	00	S		N/A	
10h	WRITE_PROTECT	80h	R/W	1	Bitmapped	Used to Control Writing to the PMBus Device 80h – Disables write except 10h 40h – Disables write except 10h, 01h, 00h 20h – Disables write except 10h, 01h, 00h, 02h and 21h 00 – Enables write to all writeable commands.

PMBus™ SPECIFICATIONS

The CNS653-M Supported PMBus™ Command List:

Command Code	Command Name	Default Value	Access Type	Data Bytes	Data Format	Description
15h	STORE_USER_ALL	-	S	0		Copies the Operating memory table to the matching USER non-volatile memory.
1Bh	SMBALERT_MASK			2	Bitmapped	
20h	VOUT_MODE	17h	R	1	Bitmapped	Specifies the mode and parameters of Output Voltage related Data Formats
21h	VOUT_COMMAND	12.0	R/W	2	Linear	Sets the Output Voltage Reference “12V” CNS653-M(U, E, F) “24V” CNS655-MU “48V” CNS658-MU Vout command sends discreet value to change or trim output voltage. The value acts as Digital reference of the Power supply after additional operations are performed (to make the representation compatible). “12-13.8V” CNS653-M(U, E, F) “24-27.6V” CNS655-MU “48-55.2V” CNS658-MU Affects OVP_WARNING and FAULT LIMIT, as well as POWER_OK_ON/OFF level.
24h	VOUT_MAX	13.8	R	2	Linear	Sets the max adjustable output voltage limit. “13.8V” CNS653-M(U, E, F) “27.6V” CNS655-MU “55.2V” CNS658-MU
35h	VIN_ON	90	R	2	Linear	90 Vac
36h	VIN_OFF	80	R	2	Linear	80 Vac
3Ah	FAN_CONFIG_1_2	90h	R	1	Bitmapped	Used to configure up to 2 fans associated with one PMBus device
	b7	1				1 – Fan is installed in position 1 0 – No Fan installed in position 1
	b6	0				1 – Fan is commanded in RPM 0 – Fan is commanded in DC
	b5:4	01				00 – 1 pulse per revolution 01 – 2 pulses per revolution 10 – 3 pulses per revolution 11 – 4 pulses per revolution
	b3	0				1 – Fan is installed in position 2 0 – No Fan installed in position 2
	b2	0				1 – Fan is commanded in RPM 0 – Fan is commanded in DC
	b1:0	00				00 – 1 pulse per revolution 01 – 2 pulses per revolution 10 – 3 pulses per revolution 11 – 4 pulses per revolution

PMBus™ SPECIFICATIONS

The CNS653-M Supported PMBus™ Command List:

Command Code	Command Name	Default Value	Access Type	Data Bytes	Data Format	Description
3Bh	FAN_COMMAND_1	0	R/W	2	Linear	Adjusts the operation of the Fans. The device may override the command, if it requires higher value, to maintain proper device temperature. RPM Control – Commands Speeds from 0-11000 RPM. Duty cycle Control – Commands Speeds from 0 to 100%
40h	VOUT_OV_FAULT_LIMIT	16.2	R	2	Linear	Sets Output Over voltage threshold. (130% to 150% of Vout)
42h	VOUT_OV_WARN_LIMIT	15	R	2	Linear	Sets Over-voltage Warning threshold. (120% to 130% of Vout)
43h	VOUT_UV_WARN_LIMIT	10.2	R	2	Linear	Sets Under-voltage Warning threshold. (80% to 90% of Vout)
44h	VOUT_UV_FAULT_LIMIT	9	R	2	Linear	Sets Under-voltage Fault threshold. (60% to 80% of Vout)
46h	IOUT_OC_FAULT_LIMIT	65	R/W	2	Linear	Sets the Over current threshold in Amps. (50% to 130% of Max Load)
47h	IOUT_OC_FAULT_RESPONSE	40h	R	1	Bitmapped	OCP ride through. If OCP persists.
4Ah	IOUT_OC_WARN_LIMIT	58.5	R	2	Linear	Sets the Over Current Warning threshold in Amps. (105% to 120% of Max Load)
4Fh	OT_FAULT_LIMIT	120	R	2	Linear	Secondary ambient temperature Fault threshold, in degree C. (120 degC)
51h	OT_WARN_LIMIT	115	R	2	Linear	Secondary ambient temperature warning threshold, in degree C. Operating limit. refer to section 3.1. (115 degC)
59h	VIN_UV_FAULT_LIMIT	80	R	2	Linear	(80Vac)
6Ah	POUT_OP_WARN_LIMIT	715	R	2	Linear	715W
78h	STATUS_BYTE	00h	R	1	Bitmapped	Returns the summary of critical faults
	b7 – BUSY					A fault was declared because the device was busy and unable to respond.
	b6 – OFF					Unit is OFF
	b5 – VOUT_OV					Output over-voltage fault has occurred
	b4 – IOUT_OC					Output over-current fault has occurred
	b3 – VIN_UV					An input under-voltage fault has occurred
	b2 – TEMPERATURE					A temperature fault or warning has occurred
	b1 – CML					A communication, memory or logic fault has occurred.
b0 – NONE OF THE ABOVE					A Fault Warning not listed in bits[7:1] has occurred.	

PMBus™ SPECIFICATIONS

The CNS653-M Supported PMBus™ Command List:

Command Code	Command Name	Default Value	Access Type	Data Bytes	Data Format	Description
79h	STATUS_WORD	0000h	R	2		Summary of units Fault and warning status.
	b15 – VOUT					An output voltage fault or warning has occurred
	b14 – IOUT/POUT					An Output current or power fault or warning has occurred.
	b13 – INPUT					An input voltage, current or power fault or warning as occurred.
	b12 – MFR					A manufacturer specific fault or warning has occurred.
	b11 – POWER_OK#					The POWER_OK signal is de-asserted
	b10 – FANS					A fan or airflow fault or warning has occurred.
	b9 – OTHER					A bit in STATUS_OTHER is set.
	b8 – UNKNOWN					A fault type not given in bits [15:1] of the STATUS_WORD has been detected.
	b7 – BUSY					A fault was declared because the device was busy and unable to respond.
	b6 – OFF					Unit is OFF
	b5 – VOUT_OV					Output over-voltage fault has occurred
	b4 – IOUT_OC					Output over-current fault has occurred
	b3 – VIN_UV					An input under-voltage fault has occurred
	b2 – TEMPERATURE					A temperature fault or warning has occurred
	b1 – CML					A communication, memory or logic fault has occurred.
b0 – NONE_OF_THE_ABOVE					A fault or warning not listed in bits[7:1] of this byte has occurred.	
7Ah	STATUS_VOUT	00h	R/W	1	Bitmapped	Output voltage related faults and warnings
	b7					VOUT Over-voltage Fault
	b6					VOUT Over-voltage warning
	b5					VOUT Under-voltage Warning
	b4					VOUT Under-voltage Fault
	b3					VOUT_MAX Warning, an attempt has been made to set output to a value higher than the highest permissible voltage.
	b2					TON_MAX_FAULT
	b1					TOFF_MAX Warning
b0					reserved	

PMBus™ SPECIFICATIONS

The CNS653-M Supported PMBus™ Command List:

Command Code	Command Name	Default Value	Access Type	Data Bytes	Data Format	Description
7Ah	STATUS_IOUT	00h	R/W	1	Bitmapped	Output Current related faults and warnings
	b7					IOUT Over current Fault
	b6					IOUT Over current And Low Voltage shutdown Fault
	b5					IOUT Overcurrent Warning
	b4					IOUT Undercurrent Fault
	b3					Current Share Fault Set if Ishare level is much greater or lower than the actual output current. Refer to Output Specifications (Table 3) for Current sharing limits.
	b2					Power Limiting
	b1					POUT Overpower Fault
7Bh	STATUS_INPUT	00h	R/W	1	Bitmapped	Input related faults and warnings
	b7					VIN Overvoltage Fault
	b6					VIN Overvoltage Warning
	b5					VIN Undervoltage Warning
	b4					VIN Undervoltage Fault
	b3					Unit is OFF for insufficient Input Voltage
	b2					IIN Overcurrent Fault
	b1					IIN Overcurrent Warning
7Ch	STATUS_VOUT	00h	R/W	1	Bitmapped	Output voltage related faults and warnings
	b7					VOUT Over-voltage Fault
	b6					VOUT Over-voltage warning
	b5					VOUT Under-voltage Warning
	b4					VOUT Under-voltage Fault
	b3					VOUT_MAX Warning, an attempt has been made to set output to a value higher than the highest permissible voltage.
	b2					TON_MAX_FAULT
	b1					TOFF_MAX Warning
7Dh	STATUS_TEMPERATURE	00h	R/W	1	Bitmapped	Temperature related faults and warnings
	b7					Overtemperature Fault
	b6					Overtemperature Warning
	b5					Undertemperature Warning
	b4					Undertemperature Fault
	b3:0					Reserved

PMBus™ SPECIFICATIONS

The CNS653-MU Supported PMBus™ Command List:

Command Code	Command Name	Default Value	Access Type	Data Bytes	Data Format	Description
7Eh	STATUS_CML	00h	R/W	1		Communications, Logic and Memory
	b7					Invalid or unsupported Command Received
	b6					
	b5					Packet Error Check Failed
	b4					Memory Fault Detect, CRC Error
	b3					
	b2					
	b1					
80h	STATUS_MFR_SPECIFIC	00h	R/W	1	Bitmapped	Manufacturer Status codes
	b7					Bulk OK, 1- Bulk is within range and is ready for use
	b6					Not Used
	b5					Not Used
	b4					Not Used
	b3					Not Used
	b2					Not Used
	b1					Standby Fault, 1 If there's a standby fault.
81h	STATUS_FANS_1_2	00h	R/W	1	Bitmapped	
	b7					Fan 1 Fault
	b6					Fan 2 Fault
	b5					Fan 1 Warning
	b4					Fan 2 Warning
	b3					Fan_1 Speed Overridden
	b2					Fan_2 Speed Overridden
	b1					
8Bh	READ_VOUT	12.1	R	2	Linear	Returns the actual voltage in volt "11.76-12.24V" CNS653-M(U, E, F) "23.52-24.48V" CNS655-MU "47.04-48.96V" CNS658-MU
8Ch	READ_IOUT	0.05	R	2	Linear	Returns the output current in amperes. "0-54.16A" CNS653-M(U, E, F) "0-27.08V" CNS655-MU "0-13.54V" CNS658-MU
90h	READ_FAN_SPEED_1	-	R	2	Linear	Speed of Fan
96h	READ_POOUT	1	R	2	Linear	Returns the output power in Watts.

PMBus™ SPECIFICATIONS

The CNS653-M Supported PMBus™ Command List:

Command Code	Command Name	Default Value	Access Type	Data Bytes	Data Format	Description
98h	PMBUS_REVISION	22h	R	1	Linear	Reads the PMBus revision
	b7:5					Part 1 Revision 0000 – Revision 1.0 0001 – Revision 1.1
	b4:0					Part 2 Revision 0000 – Revision 1.0 0001 – Revision 1.1
99h	MFR_ID	ARTESYN	BR	Varies	ASCII	Abbrev or symbol of manufacturers name.(“ARTESYN”)
9Ah	MFR_MODEL	CNS653-MU	BR	15	ASCII	Manufacturers Model number, ASCII format “CNS653-MU/F/E”
9Bh	MFR_REVISION	AT	BR	Varies	ASCII	Manufacturers, revision number, ASCII format “AA”
9Ch	MFR_LOCATION	Philippines	BR	Varies	ASCII	Manufacturers facility, ASCII format : “Philippines”
9Dh	MFR_Data	YYMMDD	BR	Varies	ASCII	Manufacture Date, ASCII format structure : “YYMMDD”
9Eh	MFR_SERIAL	L84202003ZAT C	BR	Varies	ASCII	Unit serial number, ASCII format “L842WWSSSRP000”
A0h	MFR_VIN_MIN	90	R	2	Linear	Minimum Input Voltage (90Vac)
A1h	MFR_VIN_MAX	264	R	2	Linear	Maximum Input Voltage (264Vac)
A2h	MFR_IIN_MAX	9.2	R	2	Linear	Maximum Input Current (9.2A)
A3h	MFR_PIN_MAX	828	R	2	Linear	Maximum Input Power (828W)
A4h	MFR_VOUT_MIN	12	R	2	Linear	Minimum Output Voltage Regulation Window “12V” CNS653-M(U, E, F) “24V” CNS655-MU “48V” CNS658-MU
A5h	MFR_VOUT_MAX	13.8	R	2	Linear	Maximum Output Voltage. Regulation Window “13.8V” CNS653-M(U, E, F) “27.6V” CNS655-MU “55.2V” CNS658-MU
A6h	MFR_IOUT_MAX	54.16	R	2	Linear	Maximum Output Current “54.16A” CNS653-M(U, E, F) “27.08V” CNS655-MU “13.54V” CNS658-MU
A7h	MFR_POUT_MAX	650	R	2	Linear	Maximum Output Power (650W)
A8h	MFR_TAMBIENT_MAX	50	R	2	Linear	Maximum Operating Ambient Temperature (Secondary Ambient) (50 degC)
A9h	MFR_TAMBIENT_MIN	-20	R	2	Linear	Minimum Operating Ambient Temperature (Secondary Ambient) (-20 degC)
AAh	MFR_EFFICIENCY_LL		BR	14	Linear	“115, 330, 91, 650, 90, 650, 90”
ABh	MFR_EFFICIENCY_HL		BR	14	Linear	“230, 330, 92.5, 650, 92.5, 650, 92.5”
B0h	USER_DATA_00	-		2	Hex	
E0h	FW_PRI_VERSION	00.00.00	BR	8	ASCII	
E1h	FW_SEC_VERSION	02.08.00	BR	8	ASCII	

PMBus™ SPECIFICATIONS

The CNS653-M Supported PMBus™ Command List:

Command Code	Command Name	Default Value	Access Type	Data Bytes	Data Format	Description
F1h	ISP_UNLOCK_CODE	00h,00h,00h,00h	BR/W	4	ASCII	
F2h	ISP_CTRL_CMD		R/W	1	Bitmapped	
F3h	ISP_CONFIG_STATUS	00h	R	2	Bitmapped	
F4h	ISP_FLASH_ADDR		BR/W	4	Raw Hex	
F5h	ISP_FLASH_DATA		BR/W	16	Raw Hex	

PMBus™ SPECIFICATIONS

The CNS655-MU Supported PMBus™ Command List:

Command Code	Command Name	Default Value	Access Type	Data Bytes	Data Format	Description
3Bh	FAN_COMMAND_1	0	R/W	2	Linear	Adjusts the operation of the Fans. The device may override the command, if it requires higher value, to maintain proper device temperature. RPM Control – Commands Speeds from 0-11000 RPM. Duty cycle Control – Commands Speeds from 0 to 100%
40h	VOUT_OV_FAULT_LIMIT	32.3	R	2	Linear	Sets Output Over voltage threshold. (130% to 150% of Vout)
42h	VOUT_OV_WARN_LIMIT	30	R	2	Linear	Sets Over-voltage Warning threshold. (120% to 130% of Vout)
43h	VOUT_UV_WARN_LIMIT	20.4	R	2	Linear	Sets Under-voltage Warning threshold. (80% to 90% of Vout)
44h	VOUT_UV_FAULT_LIMIT	18	R	2	Linear	Sets Under-voltage Fault threshold. (60% to 80% of Vout)
46h	IOUT_OC_FAULT_LIMIT	32.5	R/W	2	Linear	Sets the Over current threshold in Amps. (50% to 130% of Max Load)
47h	IOUT_OC_FAULT_RESPONSE	40h	R	1	Bitmapped	OCP ride through. If OCP persists.
4Ah	IOUT_OC_WARN_LIMIT	29.2	R	2	Linear	Sets the Over Current Warning threshold in Amps. (105% to 120% of Max Load)
4Fh	OT_FAULT_LIMIT	120	R	2	Linear	Secondary ambient temperature Fault threshold, in degree C. (120 degC)
51h	OT_WARN_LIMIT	115	R	2	Linear	Secondary ambient temperature warning threshold, in degree C. Operating limit. refer to section 3.1. (115 degC)
59h	VIN_UV_FAULT_LIMIT	80	R	2	Linear	(80Vac)
6Ah	POUT_OP_WARN_LIMIT	715	R	2	Linear	715W
78h	STATUS_BYTE	00h	R	1	Bitmapped	Returns the summary of critical faults
	b7 – BUSY					A fault was declared because the device was busy and unable to respond.
	b6 – OFF					Unit is OFF
	b5 – VOUT_OV					Output over-voltage fault has occurred
	b4 – IOUT_OC					Output over-current fault has occurred
	b3 – VIN_UV					An input under-voltage fault has occurred
	b2 – TEMPERATURE					A temperature fault or warning has occurred
	b1 – CML					A communication, memory or logic fault has occurred.
b0 – NONE OF THE ABOVE					A Fault Warning not listed in bits[7:1] has occurred.	

PMBus™ SPECIFICATIONS

The CNS655-MU Supported PMBus™ Command List:

Command Code	Command Name	Default Value	Access Type	Data Bytes	Data Format	Description
79h	STATUS_WORD	0000h	R	2		Summary of units Fault and warning status.
	b15 – VOUT					An output voltage fault or warning has occurred
	b14 – IOUT/POUT					An Output current or power fault or warning has occurred.
	b13 – INPUT					An input voltage, current or power fault or warning as occurred.
	b12 – MFR					A manufacturer specific fault or warning has occurred.
	b11 – POWER_OK#					The POWER_OK signal is de-asserted
	b10 – FANS					A fan or airflow fault or warning has occurred.
	b9 – OTHER					A bit in STATUS_OTHER is set.
	b8 – UNKNOWN					A fault type not given in bits [15:1] of the STATUS_WORD has been detected.
	b7 – BUSY					A fault was declared because the device was busy and unable to respond.
	b6 – OFF					Unit is OFF
	b5 – VOUT_OV					Output over-voltage fault has occurred
	b4 – IOUT_OC					Output over-current fault has occurred
	b3 – VIN_UV					An input under-voltage fault has occurred
	b2 – TEMPERATURE					A temperature fault or warning has occurred
	b1 – CML					A communication, memory or logic fault has occurred.
b0 – NONE_OF_THE_ABOVE					A fault or warning not listed in bits[7:1] of this byte has occurred.	
7Ah	STATUS_VOUT	00h	R/W	1	Bitmapped	Output voltage related faults and warnings
	b7					VOUT Over-voltage Fault
	b6					VOUT Over-voltage warning
	b5					VOUT Under-voltage Warning
	b4					VOUT Under-voltage Fault
	b3					VOUT_MAX Warning, an attempt has been made to set output to a value higher than the highest permissible voltage.
	b2					TON_MAX_FAULT
	b1					TOFF_MAX Warning
b0					reserved	

PMBus™ SPECIFICATIONS

The CNS655-MU Supported PMBus™ Command List:

Command Code	Command Name	Default Value	Access Type	Data Bytes	Data Format	Description
7Ah	STATUS_IOUT	00h	R/W	1	Bitmapped	Output Current related faults and warnings
	b7					IOUT Over current Fault
	b6					IOUT Over current And Low Voltage shutdown Fault
	b5					IOUT Overcurrent Warning
	b4					IOUT Undercurrent Fault
	b3					Current Share Fault Set if Ishare level is much greater or lower than the actual output current. Refer to Output Specifications (Table 3) for Current sharing limits.
	b2					Power Limiting
	b1					POUT Overpower Fault
7Bh	STATUS_INPUT	00h	R/W	1	Bitmapped	Input related faults and warnings
	b7					VIN Overvoltage Fault
	b6					VIN Overvoltage Warning
	b5					VIN Undervoltage Warning
	b4					VIN Undervoltage Fault
	b3					Unit is OFF for insufficient Input Voltage
	b2					IIN Overcurrent Fault
	b1					IIN Overcurrent Warning
7Ch	STATUS_VOUT	00h	R/W	1	Bitmapped	Output voltage related faults and warnings
	b7					VOUT Over-voltage Fault
	b6					VOUT Over-voltage warning
	b5					VOUT Under-voltage Warning
	b4					VOUT Under-voltage Fault
	b3					VOUT_MAX Warning, an attempt has been made to set output to a value higher than the highest permissible voltage.
	b2					TON_MAX_FAULT
	b1					TOFF_MAX Warning
7Dh	STATUS_TEMPERATURE	00h	R/W	1	Bitmapped	Temperature related faults and warnings
	b7					Overtemperature Fault
	b6					Overtemperature Warning
	b5					Undertemperature Warning
	b4					Undertemperature Fault
	b3:0					Reserved

PMBus™ SPECIFICATIONS

The CNS655-MU Supported PMBus™ Command List:

Command Code	Command Name	Default Value	Access Type	Data Bytes	Data Format	Description
7Eh	STATUS_CML	00h	R/W	1		Communications, Logic and Memory
	b7					Invalid or unsupported Command Received
	b6					
	b5					Packet Error Check Failed
	b4					Memory Fault Detect, CRC Error
	b3					
	b2					
	b1					
80h	STATUS_MFR_SPECIFIC	00h	R/W	1	Bitmapped	Manufacturer Status codes
	b7					Bulk OK, 1- Bulk is within range and is ready for use
	b6					Not Used
	b5					Not Used
	b4					Not Used
	b3					Not Used
	b2					Not Used
	b1					Standby Fault, 1 If there's a standby fault.
81h	STATUS_FANS_1_2	00h	R/W	1	Bitmapped	
	b7					Fan 1 Fault
	b6					Fan 2 Fault
	b5					Fan 1 Warning
	b4					Fan 2 Warning
	b3					Fan_1 Speed Overridden
	b2					Fan_2 Speed Overridden
	b1					
8Bh	READ_VOUT	24.17	R	2	Linear	Returns the actual voltage in volt "11.76-12.24V" CNS653-M(U, E, F) "23.52-24.48V" CNS655-MU "47.04-48.96V" CNS658-MU
8Ch	READ_IOUT	0.12	R	2	Linear	Returns the output current in amperes. "0-54.16A" CNS653-M(U, E, F) "0-27.08V" CNS655-MU "0-13.54V" CNS658-MU
90h	READ_FAN_SPEED_1	-	R	2	Linear	Speed of Fan
96h	READ_POUT	3	R	2	Linear	Returns the output power in Watts.

PMBus™ SPECIFICATIONS

The CNS655-MU Supported PMBus™ Command List:

Command Code	Command Name	Default Value	Access Type	Data Bytes	Data Format	Description
98h	PMBUS_REVISION	22h	R	1	Linear	Reads the PMBus revision
	b7:5					Part 1 Revision 0000 – Revision 1.0 0001 – Revision 1.1
	b4:0					Part 2 Revision 0000 – Revision 1.0 0001 – Revision 1.1
99h	MFR_ID	ARTESYN	BR	Varies	ASCII	Abbrev or symbol of manufacturers name.(“ARTESYN”)
9Ah	MFR_MODEL	CNS655-MU	BR	15	ASCII	Manufacturers Model number, ASCII format “CNS655-MU”
9Bh	MFR_REVISION	AP	BR	Varies	ASCII	Manufacturers, revision number, ASCII format “AA”
9Ch	MFR_LOCATION	Philippines	BR	Varies	ASCII	Manufacturers facility, ASCII format : “Philippines”
9Dh	MFR_Data	YYMMDD	BR	Varies	ASCII	Manufacture Date, ASCII format structure : “YYMMDD”
9Eh	MFR_SERIAL	L8461N0059AP C	BR	Varies	ASCII	Unit serial number, ASCII format “L842WWSSSRP000”
A0h	MFR_VIN_MIN	90	R	2	Linear	Minimum Input Voltage (90Vac)
A1h	MFR_VIN_MAX	264	R	2	Linear	Maximum Input Voltage (264Vac)
A2h	MFR_IIN_MAX	9.2	R	2	Linear	Maximum Input Current (9.2A)
A3h	MFR_PIN_MAX	828	R	2	Linear	Maximum Input Power (828W)
A4h	MFR_VOUT_MIN	48	R	2	Linear	Minimum Output Voltage Regulation Window “12V” CNS653-M(U, E, F) “24V” CNS655-MU “48V” CNS658-MU
A5h	MFR_VOUT_MAX	55.2	R	2	Linear	Maximum Output Voltage. Regulation Window “13.8V” CNS653-M(U, E, F) “27.6V” CNS655-MU “55.2V” CNS658-MU
A6h	MFR_IOUT_MAX	27.09	R	2	Linear	Maximum Output Current “54.16A” CNS653-M(U, E, F) “27.08V” CNS655-MU “13.54V” CNS658-MU
A7h	MFR_POUT_MAX	650	R	2	Linear	Maximum Output Power (650W)
A8h	MFR_TAMBIENT_MAX	50	R	2	Linear	Maximum Operating Ambient Temperature (Secondary Ambient) (50 degC)
A9h	MFR_TAMBIENT_MIN	-20	R	2	Linear	Minimum Operating Ambient Temperature (Secondary Ambient) (-20 degC)
AAh	MFR_EFFICIENCY_LL		BR	14	Linear	“115, 330, 91, 650, 90, 650, 90”
ABh	MFR_EFFICIENCY_HL		BR	14	Linear	“230, 330, 92.5, 650, 92.5, 650, 92.5”
B0h	USER_DATA_00	-		2	Hex	
E0h	FW_PRI_VERSION	00.00.00	BR	8	ASCII	
E1h	FW_SEC_VERSION	02.06.00	BR	8	ASCII	

PMBus™ SPECIFICATIONS

The CNS655-MU Supported PMBus™ Command List:

Command Code	Command Name	Default Value	Access Type	Data Bytes	Data Format	Description
F1h	ISP_UNLOCK_CODE	00h,00h,00h,00h	BR/W	4	ASCII	
F2h	ISP_CTRL_CMD		R/W	1	Bitmapped	
F3h	ISP_CONFIG_STATUS	00h	R	2	Bitmapped	
F4h	ISP_FLASH_ADDR		BR/W	4	Raw Hex	
F5h	ISP_FLASH_DATA		BR/W	16	Raw Hex	

PMBus™ SPECIFICATIONS

The CNS658-MU Supported PMBus™ Command List:

Command Code	Command Name	Default Value	Access Type	Data Bytes	Data Format	Description
00h	PAGE	00h	R	1	Hex	
01h	OPERATION	80h	R/W	1	Bitmapped	Used to turn the unit ON/OFF in conjunction with the input INH_EN pin.
	b7:6	10				01 – Soft Turn OFF (With Sequencing) 10 - PSU ON
	b5:4	00				
	b3:2	00				
	b1:0	00				Reserved
02h	ON_OFF_CONFIG	1Eh	R	1	Bitmapped	Configures the combination of INH_EN pin and serial communication commands needed to turn the unit ON/OFF.
	b7:5	000				Reserved
	b4 – Enable INH_EN pin and Serial communication control.	1				0 – Unit powers up any time power is present regardless of the state of INH_EN pin. 1 – Unit powers up as dictated by INH_EN pin and OPERATION command (b3:0).
	b3 – Serial communication Control	1				0 – Unit Ignores ON/OFF portion of the OPERATION command. 1 – Enables Serial communication ON/OFF portion of OPERATION command. Requires INH_EN pin to be asserted for the unit to start and energize the output.
	b2 – Sets how the unit responds to INH_EN pin	1				0 – Unit ignores INH_EN pin. (ON/OFF controlled by OPERATION command). 1 – Unit requires INH_EN pin to be asserted to start the unit.
	b1 – INH_EN pin polarity	1				0 – Active Low (Pull Low to start the unit). 1 – Active high (Pull high to start the unit).
	b0 – INH_ENL pin action	0				0 – Use programmed turn ON/OFF delay. 1 – Turn OFF the output and stop transferring energy to the output as fast as possible.
03h	CLEAR_FAULTS	00	S		N/A	
10h	WRITE_PROTECT	80h	R/W	1	Bitmapped	Used to Control Writing to the PMBus Device 80h – Disables write except 10h 40h – Disables write except 10h, 01h, 00h 20h – Disables write except 10h, 01h, 00h, 02h and 21h 00 – Enables write to all writeable commands.

PMBus™ SPECIFICATIONS

The CNS658-MU Supported PMBus™ Command List:

Command Code	Command Name	Default Value	Access Type	Data Bytes	Data Format	Description
15h	STORE_USER_ALL	-	S	0		Copies the Operating memory table to the matching USER non-volatile memory.
1Bh	SMBALERT_MASK			2	Bitmapped	
20h	VOUT_MODE	17h	R	1	Bitmapped	Specifies the mode and parameters of Output Voltage related Data Formats
21h	VOUT_COMMAND	48.1	R/W	2	Linear	Sets the Output Voltage Reference “12V” CNS653-M(U, E, F) “24V” CNS655-MU “48V” CNS658-MU Vout command sends discreet value to change or trim output voltage. The value acts as Digital reference of the Power supply after additional operations are performed (to make the representation compatible). “12-13.8V” CNS653-M(U, E, F) “24-27.6V” CNS655-MU “48-55.2V” CNS658-MU Affects OVP_WARNING and FAULT LIMIT, as well as POWER_OK_ON/OFF level.
24h	VOUT_MAX	55.2	R	2	Linear	Sets the max adjustable output voltage limit. “13.8V” CNS653-M(U, E, F) “27.6V” CNS655-MU “55.2V” CNS658-MU
35h	VIN_ON	90	R	2	Linear	90 Vac
36h	VIN_OFF	80	R	2	Linear	80 Vac
3Ah	FAN_CONFIG_1_2	90h	R	1	Bitmapped	Used to configure up to 2 fans associated with one PMBus device
	b7	1				1 – Fan is installed in position 1 0 – No Fan installed in position 1
	b6	0				1 – Fan is commanded in RPM 0 – Fan is commanded in DC
	b5:4	01				00 – 1 pulse per revolution 01 – 2 pulses per revolution 10 – 3 pulses per revolution 11 – 4 pulses per revolution
	b3	0				1 – Fan is installed in position 2 0 – No Fan installed in position 2
	b2	0				1 – Fan is commanded in RPM 0 – Fan is commanded in DC
	b1:0	00				00 – 1 pulse per revolution 01 – 2 pulses per revolution 10 – 3 pulses per revolution 11 – 4 pulses per revolution

PMBus™ SPECIFICATIONS

The CNS658-MU Supported PMBus™ Command List:

Command Code	Command Name	Default Value	Access Type	Data Bytes	Data Format	Description
3Bh	FAN_COMMAND_1	0	R/W	2	Linear	Adjusts the operation of the Fans. The device may override the command, if it requires higher value, to maintain proper device temperature. RPM Control – Commands Speeds from 0-11000 RPM. Duty cycle Control – Commands Speeds from 0 to 100%
40h	VOUT_OV_FAULT_LIMIT	63.2	R	2	Linear	Sets Output Over voltage threshold. (130% to 150% of Vout)
42h	VOUT_OV_WARN_LIMIT	60	R	2	Linear	Sets Over-voltage Warning threshold. (120% to 130% of Vout)
43h	VOUT_UV_WARN_LIMIT	40.8	R	2	Linear	Sets Under-voltage Warning threshold. (80% to 90% of Vout)
44h	VOUT_UV_FAULT_LIMIT	36	R	2	Linear	Sets Under-voltage Fault threshold. (60% to 80% of Vout)
46h	IOUT_OC_FAULT_LIMIT	16.2	R/W	2	Linear	Sets the Over current threshold in Amps. (50% to 130% of Max Load)
47h	IOUT_OC_FAULT_RESPONSE	40h	R	1	Bitmapped	OCP ride through. If OCP persists.
4Ah	IOUT_OC_WARN_LIMIT	14.6	R	2	Linear	Sets the Over Current Warning threshold in Amps. (105% to 120% of Max Load)
4Fh	OT_FAULT_LIMIT	120	R	2	Linear	Secondary ambient temperature Fault threshold, in degree C. (120 degC)
51h	OT_WARN_LIMIT	115	R	2	Linear	Secondary ambient temperature warning threshold, in degree C. Operating limit. refer to section 3.1. (115 degC)
59h	VIN_UV_FAULT_LIMIT	80	R	2	Linear	(80Vac)
6Ah	POUT_OP_WARN_LIMIT	715	R	2	Linear	715W
78h	STATUS_BYTE	00h	R	1	Bitmapped	Returns the summary of critical faults
	b7 – BUSY					A fault was declared because the device was busy and unable to respond.
	b6 – OFF					Unit is OFF
	b5 – VOUT_OV					Output over-voltage fault has occurred
	b4 – IOUT_OC					Output over-current fault has occurred
	b3 – VIN_UV					An input under-voltage fault has occurred
	b2 – TEMPERATURE					A temperature fault or warning has occurred
	b1 – CML					A communication, memory or logic fault has occurred.
b0 – NONE OF THE ABOVE					A Fault Warning not listed in bits[7:1] has occurred.	

PMBus™ SPECIFICATIONS

The CNS658-MU Supported PMBus™ Command List:

Command Code	Command Name	Default Value	Access Type	Data Bytes	Data Format	Description
79h	STATUS_WORD	0000h	R	2		Summary of units Fault and warning status.
	b15 – VOUT					An output voltage fault or warning has occurred
	b14 – IOUT/POUT					An Output current or power fault or warning has occurred.
	b13 – INPUT					An input voltage, current or power fault or warning as occurred.
	b12 – MFR					A manufacturer specific fault or warning has occurred.
	b11 – POWER_OK#					The POWER_OK signal is de-asserted
	b10 – FANS					A fan or airflow fault or warning has occurred.
	b9 – OTHER					A bit in STATUS_OTHER is set.
	b8 – UNKNOWN					A fault type not given in bits [15:1] of the STATUS_WORD has been detected.
	b7 – BUSY					A fault was declared because the device was busy and unable to respond.
	b6 – OFF					Unit is OFF
	b5 – VOUT_OV					Output over-voltage fault has occurred
	b4 – IOUT_OC					Output over-current fault has occurred
	b3 – VIN_UV					An input under-voltage fault has occurred
	b2 – TEMPERATURE					A temperature fault or warning has occurred
	b1 – CML					A communication, memory or logic fault has occurred.
b0 – NONE_OF_THE_ABOVE					A fault or warning not listed in bits[7:1] of this byte has occurred.	
7Ah	STATUS_VOUT	00h	R/W	1	Bitmapped	Output voltage related faults and warnings
	b7					VOUT Over-voltage Fault
	b6					VOUT Over-voltage warning
	b5					VOUT Under-voltage Warning
	b4					VOUT Under-voltage Fault
	b3					VOUT_MAX Warning, an attempt has been made to set output to a value higher than the highest permissible voltage.
	b2					TON_MAX_FAULT
	b1					TOFF_MAX Warning
b0					reserved	

PMBus™ SPECIFICATIONS

The CNS658-MU Supported PMBus™ Command List:

Command Code	Command Name	Default Value	Access Type	Data Bytes	Data Format	Description
7Ah	STATUS_IOUT	00h	R/W	1	Bitmapped	Output Current related faults and warnings
	b7					IOUT Over current Fault
	b6					IOUT Over current And Low Voltage shutdown Fault
	b5					IOUT Overcurrent Warning
	b4					IOUT Undercurrent Fault
	b3					Current Share Fault Set if Ishare level is much greater or lower than the actual output current. Refer to Output Specifications (Table 3) for Current sharing limits.
	b2					Power Limiting
	b1					POUT Overpower Fault
7Bh	STATUS_INPUT	00h	R/W	1	Bitmapped	Input related faults and warnings
	b7					VIN Overvoltage Fault
	b6					VIN Overvoltage Warning
	b5					VIN Undervoltage Warning
	b4					VIN Undervoltage Fault
	b3					Unit is OFF for insufficient Input Voltage
	b2					IIN Overcurrent Fault
	b1					IIN Overcurrent Warning
7Ch	STATUS_VOUT	00h	R/W	1	Bitmapped	Output voltage related faults and warnings
	b7					VOUT Over-voltage Fault
	b6					VOUT Over-voltage warning
	b5					VOUT Under-voltage Warning
	b4					VOUT Under-voltage Fault
	b3					VOUT_MAX Warning, an attempt has been made to set output to a value higher than the highest permissible voltage.
	b2					TON_MAX_FAULT
	b1					TOFF_MAX Warning
7Dh	STATUS_TEMPERATURE	00h	R/W	1	Bitmapped	Temperature related faults and warnings
	b7					Overtemperature Fault
	b6					Overtemperature Warning
	b5					Undertemperature Warning
	b4					Undertemperature Fault
	b3:0					Reserved

PMBus™ SPECIFICATIONS

The CNS658-MU Supported PMBus™ Command List:

Command Code	Command Name	Default Value	Access Type	Data Bytes	Data Format	Description
7Eh	STATUS_CML	00h	R/W	1		Communications, Logic and Memory
	b7					Invalid or unsupported Command Received
	b6					
	b5					Packet Error Check Failed
	b4					Memory Fault Detect, CRC Error
	b3					
	b2					
	b1					
80h	STATUS_MFR_SPECIFIC	00h	R/W	1	Bitmapped	Manufacturer Status codes
	b7					Bulk OK, 1- Bulk is within range and is ready for use
	b6					Not Used
	b5					Not Used
	b4					Not Used
	b3					Not Used
	b2					Not Used
	b1					Standby Fault, 1 If there's a standby fault.
81h	STATUS_FANS_1_2	00h	R/W	1	Bitmapped	
	b7					Fan 1 Fault
	b6					Fan 2 Fault
	b5					Fan 1 Warning
	b4					Fan 2 Warning
	b3					Fan_1 Speed Overridden
	b2					Fan_2 Speed Overridden
	b1					
8Bh	READ_VOUT	48.15	R	2	Linear	Returns the actual voltage in volt "11.76-12.24V" CNS653-M(U, E, F) "23.52-24.48V" CNS655-MU "47.04-48.96V" CNS658-MU
8Ch	READ_IOUT	0	R	2	Linear	Returns the output current in amperes. "0-54.16A" CNS653-M(U, E, F) "0-27.08V" CNS655-MU "0-13.54V" CNS658-MU
90h	READ_FAN_SPEED_1	-	R	2	Linear	Speed of Fan
96h	READ_POUT	0	R	2	Linear	Returns the output power in Watts.

PMBus™ SPECIFICATIONS

The CNS658-MU Supported PMBus™ Command List:

Command Code	Command Name	Default Value	Access Type	Data Bytes	Data Format	Description
98h	PMBUS_REVISION	22h	R	1	Linear	Reads the PMBus revision
	b7:5					Part 1 Revision 0000 – Revision 1.0 0001 – Revision 1.1
	b4:0					Part 2 Revision 0000 – Revision 1.0 0001 – Revision 1.1
99h	MFR_ID	ARTESYN	BR	Varies	ASCII	Abbrev or symbol of manufacturers name.(“ARTESYN”)
9Ah	MFR_MODEL	CNS658-MU	BR	15	ASCII	Manufacturers Model number, ASCII format “CNS658-MU”
9Bh	MFR_REVISION	AP	BR	Varies	ASCII	Manufacturers, revision number, ASCII format “AA”
9Ch	MFR_LOCATION	Philippines	BR	Varies	ASCII	Manufacturers facility, ASCII format : “Philippines”
9Dh	MFR_Data	YYMMDD	BR	Varies	ASCII	Manufacture Date, ASCII format structure : “YYMMDD”
9Eh	MFR_SERIAL	L847VX004BAP C	BR	Varies	ASCII	Unit serial number, ASCII format “L842WWSSSRP000”
A0h	MFR_VIN_MIN	90	R	2	Linear	Minimum Input Voltage (90Vac)
A1h	MFR_VIN_MAX	264	R	2	Linear	Maximum Input Voltage (264Vac)
A2h	MFR_IIN_MAX	9.2	R	2	Linear	Maximum Input Current (9.2A)
A3h	MFR_PIN_MAX	828	R	2	Linear	Maximum Input Power (828W)
A4h	MFR_VOUT_MIN	48	R	2	Linear	Minimum Output Voltage Regulation Window “12V” CNS653-M(U, E, F) “24V” CNS655-MU “48V” CNS658-MU
A5h	MFR_VOUT_MAX	55.2	R	2	Linear	Maximum Output Voltage. Regulation Window “13.8V” CNS653-M(U, E, F) “27.6V” CNS655-MU “55.2V” CNS658-MU
A6h	MFR_IOUT_MAX	13.54	R	2	Linear	Maximum Output Current “54.16A” CNS653-M(U, E, F) “27.08V” CNS655-MU “13.54V” CNS658-MU
A7h	MFR_POUT_MAX	650	R	2	Linear	Maximum Output Power (650W)
A8h	MFR_TAMBIENT_MAX	50	R	2	Linear	Maximum Operating Ambient Temperature (Secondary Ambient) (50 degC)
A9h	MFR_TAMBIENT_MIN	-20	R	2	Linear	Minimum Operating Ambient Temperature (Secondary Ambient) (-20 degC)
AAh	MFR_EFFICIENCY_LL		BR	14	Linear	“115, 330, 91, 650, 90, 650, 90”
ABh	MFR_EFFICIENCY_HL		BR	14	Linear	“230, 330, 92.5, 650, 92.5, 650, 92.5”
B0h	USER_DATA_00	-		2	Hex	
E0h	FW_PRI_VERSION	00.00.00	BR	8	ASCII	
E1h	FW_SEC_VERSION	01.08.01	BR	8	ASCII	

PMBus™ SPECIFICATIONS

The CNS658-MU Supported PMBus™ Command List:

Command Code	Command Name	Default Value	Access Type	Data Bytes	Data Format	Description
F1h	ISP_UNLOCK_CODE	00h,00h,00h,00h	BR/W	4	ASCII	
F2h	ISP_CTRL_CMD		R/W	1	Bitmapped	
F3h	ISP_CONFIG_STATUS	00h	R	2	Bitmapped	
F4h	ISP_FLASH_ADDR		BR/W	4	Raw Hex	
F5h	ISP_FLASH_DATA		BR/W	16	Raw Hex	

APPLICATION NOTES

Output Ripple and Noise Measurement

The setup outlined in the diagram below has been used for output voltage ripple and noise measurements on the CNS650-M series. When measuring output ripple and noise, a scope jack in parallel with a 0.1uF ceramic chip capacitor, and a 10 uF aluminum electrolytic capacitor should be used. Oscilloscope should be set to 20 MHz bandwidth for this measurement.

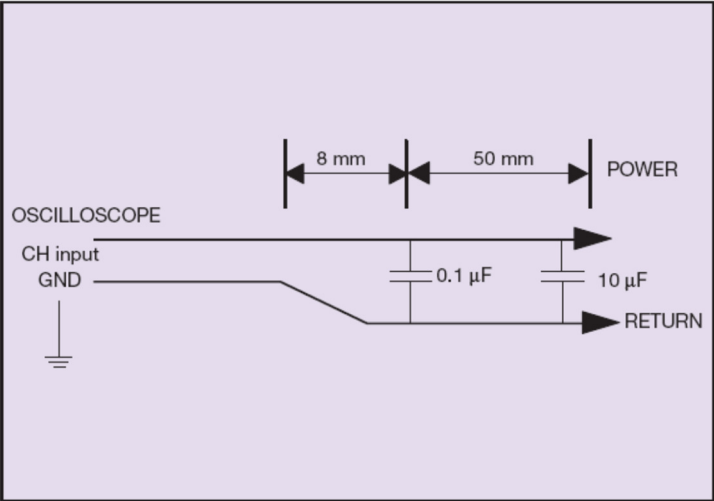

RECORD OF REVISION AND CHANGES

Issue	Date	Description	Originators
1.0	01.25.2017	First Issue	E. Bai
1.1	08.24.2017	Remove note1 about parallel units on page 6 Correct the Temperature on page 15	E. Bai
1.2	12.04.2017	Correct the MTBF	E. Bai
1.3	03.14.2018	Correct the device addressing, and I2C time out	E. Bai
1.4	03.22.2018	Add "Note 3 - To achieve the input power lower than 0.5W, communication and all signals are disabled and only the inhibit pin is active." on page 4	E. Bai
1.5	07.05.2019	Add detail description for fan header pins	E. Bai
1.6	12.18.2019	SDA, SCL external pull up resister changed to 2.2Kohm	E. Bai
1.7	06.04.2020	Efficiency curve, production hi-pot update, standby preload	E. Bai
1.8	06.18.2020	Update safety cert from 60950 to 62368-1	E. Bai
1.9	10.13.2020	Delete command 8D, and I2C external pull-up resistor is changed to "recommended", not "must" on page 32	E. Bai
2.0	08.25.2021	Change the Power Factor and Harmonic conditions on page 4	E. Bai
2.1	09.27.2021	PMBus Command List Check	E. Bai
2.2	05.05.2022	Update UKCA safety mark and delete Class II on page 23	E. Bai
2.3	10.08.2022	Add note for PF at 360 to 400 Hz input frequency	E. Wang
2.4	07.24.2023	Change IEC 60601-1-2 4 th Edition to IEC 60601-1 3.1 Edition on page 1	E. Bai
2.5	01.07.2025	Change the remote sense compensation from 115% to 5V	E. Bai



For international contact information,
visit advancedenergy.com.

powersales@aei.com (Sales Support)
productsupport.ep@aei.com (Technical Support)
+1 888 412 7832

ABOUT ADVANCED ENERGY

Advanced Energy (AE) has devoted more than three decades to perfecting power for its global customers. AE designs and manufactures highly engineered, precision power conversion, measurement and control solutions for mission-critical applications and processes.

Our products enable customer innovation in complex applications for a wide range of industries including semiconductor equipment, industrial, manufacturing, telecommunications, data center computing, and medical. With deep applications know-how and responsive service and support across the globe, we build collaborative partnerships to meet rapid technological developments, propel growth for our customers, and innovate the future of power.

PRECISION | POWER | PERFORMANCE

Specifications are subject to change without notice. Not responsible for errors or omissions. ©2020 Advanced Energy Industries, Inc. All rights reserved. Advanced Energy®, and AE® are U.S. trademarks of Advanced Energy Industries, Inc.