

# ARTESYN

## AGQ500-48S50-6L SERIES

### 500 Watts Quarter brick Converter



## PRODUCT DESCRIPTION

The AGQ500-48S50-6L is a single output DC-DC converter with standard quarter-brick outline and pin configuration. It delivers up to 10A output current with 50V output voltage. Above 94% ultra-high efficiency and excellent thermal performance makes it an ideal choice to supply power to a power amplifier in telecom and data-com. The aluminum baseplate structure makes it possible for the module to work under  $-40^{\circ}\text{C} \sim +85^{\circ}\text{C}$  with air cooling and baseplate operating temperature up to  $100^{\circ}\text{C}$ .

## SPECIAL FEATURES

- Delivering up to 10A output
- Ultra-high efficiency 94.0% typ. at full load
- Input range: 36V to 75Vdc
- Basic isolation
- High power density
- Low output noise
- Excellent thermal performance
- No minimum load requirement
- RoHS 3.0
- Remote control function
- Remote output sense
- Trim function: 50% ~ 114%
- Input under-voltage lockout
- Output over current protection
- Output over voltage protection
- Output short circuit protection
- Industry standard quarter-brick

- Over temperature protection

## SAFETY

- UL/CSA/IEC/EN62368 (60950-1)
- CE Mark
- UL/TUV

## TYPICAL APPLICATIONS

- Telecom/ Datacom

## AT A GLANCE

### Total Power

500 Watts

### Input Voltage

36 to 75 Vdc

### # of Outputs

Single



## MODEL NUMBERS

Standard	Output Voltage	Structure	Remote ON/OFF logic	RoHS Status
AGQ500-48S50-6L	50Vdc	Baseplate	Negative	RoHS3.0
AGQ500-48S50P-6L	50Vdc	Baseplate	Positive	RoHS3.0

### Ordering Information

AGQ500	-	48	S	50	P	-	6	L
①		②	③	④	⑤		⑥	⑦

①	Model series	AGQ: series name, 500:output power 500W
②	Input voltage	48: 36V ~ 75V input range, rated input voltage 48V
③	Output number	S: single output
④	Rated output voltage	50: 50V output
⑤	Remote on/off logic	Default: negative logic; P: positive logic
⑥	Pin length	6: 3.8mm
⑦	RoHS status	RoHS 3.0

### Options

None

## ELECTRICAL SPECIFICATIONS

### Absolute Maximum Ratings

Stress in excess of those listed in the “Absolute Maximum Ratings” may cause permanent damage to the power supply. These are stress ratings only and functional operation of the unit is not implied at these or any other conditions above those given in the operational sections of this TRN. Exposure to any absolute maximum rated condition for extended periods may adversely affect the power supply’s reliability.

Table 1. Absolute Maximum Ratings						
Parameter	Model	Symbol	Min	Typ	Max	Unit
Input Voltage	Operating	$V_{IN,DC}$	-	-	100	Vdc
	Non-operating		-	-	80	Vdc
Ambient Operating Temperature	All models	$T_A$	-40	-	+85	°C
Voltage at remote ON/OFF pin	All models		-0.3	-	15	Vdc
Storage Temperature	All models	$T_{STG}$	-55	-	+125	°C
Isolation Voltage <sup>1</sup>	Input to output <sup>2</sup>	All models	2250	-	-	Vdc
	Output to metal <sup>3</sup>	All models	1500	-	-	Vdc
	Input to metal	All models	1000	-	-	Vdc
Voltage at Remote ON/OFF control (negative logic)	Off-state voltage	All models	2.4	-	15	Vdc
	On-state voltage	All models	-0.3	-	0.8	Vdc
Voltage at Remote ON/OFF control (positive logic)	Off-state voltage	All models	-0.3	-	0.8	Vdc
	On-state voltage	All models	2.4	-	15	Vdc
MTBF	Telcordia SR-332-2006 80% load, 300LFM, 40°C		-	1.5	-	10 <sup>6</sup> hrs

Note 1 - Condition: 1mA for 60S, slew rate of 1500V/10S.

Note 2 - Basic insulation, pollution degree 2.

Note 3 - Functional insulation, pollution degree 2.

## ELECTRICAL SPECIFICATIONS

### Input Specifications

Table 2. Input Specifications							
Parameter	Conditions <sup>1</sup>	Symbol	Min	Typ	Max	Unit	
Operating Input Voltage, DC	All	$V_{IN,DC}$	36	48	75	Vdc	
Input Under Voltage Lockout	Turn-on voltage Threshold	$I_O=I_{O,max}$	$V_{IN,ON}$	33	-	36	Vdc
	Turn-off voltage Threshold	$I_O=I_{O,max}$	$V_{IN,OFF}$	31	-	35	Vdc
	Lockout voltage Hysteresis	$I_O=I_{O,max}$		1	-	3	Vdc
Maximum Input Current	$V_{IN,DC}=V_{IN,min}$ $I_O=I_{O,max}$	$I_{IN,max}$	-	-	15	A	
Input Reflected Ripple Current <sup>2</sup> (peak-peak)	Through 12 $\mu$ H inductor		-	9.5		mA	
Efficiency	$V_{IN,DC}=48Vdc$ $I_O=I_{O,max}$ $I_O=50\%I_{O,max}$	$\eta$	94	-	95	%	
Input Fuse <sup>3</sup>	External fast blow fuse is recommended		-	-	30	A	
Recommended External Input Capacitance <sup>4</sup>	Low ESR capacitor recommended	$C_{IN}$	470	-	-	$\mu$ F	

Note 1 -  $T_A=25^\circ C$ , airflow rate = 400LFM,  $V_{IN,DC}=48Vdc$ , nominal output voltage unless otherwise noted

Note 2 - See figure 19 for more details.

Note 3 - See figure 14 for more details.

Note 4 - See figure 14 for more details.

## ELECTRICAL SPECIFICATIONS

## Output Specifications

Table 3. Output Specifications							
Parameter	Conditions <sup>1</sup>	Symbol	Min	Typ	Max	Unit	
Output Voltage Set-Point	$V_{IN,DC}=V_{IN,nom}$ $I_O=50\%I_{O,max}$ $T_A=25\text{ }^\circ\text{C}$	$V_O$	49.5	50	50.5	Vdc	
Output Voltage Line Regulation	$V_{IN,DC}=V_{IN,min}$ to $V_{IN,max}$	$\pm V_O$	- -	- -	0.5 250	% mV	
Output Voltage Load Regulation	$I_O=I_{O,min}$ to $I_{O,max}$	$\pm V_O$	- -	- -	0.5 250	% mV	
Output Voltage Temperature Regulation	All	$\%V_O$	-	-	0.02	$\%/^\circ\text{C}$	
Operating Output Current Range	All	$I_O$	0	-	10	A	
Operating Output Voltage Range	All	$V_O$	48.5	50	51.5	Vdc	
Output Over Current Protection <sup>2</sup>	All	$I_{O,max}$	13	-	20	A	
Output Ripple, pk-pk <sup>3</sup>	Measure with a 4.7 $\mu\text{F}$ ceramic capacitor in parallel with a 10 $\mu\text{F}$ tantalum capacitor, 0 to 20MHz bandwidth	$V_O$	-	100	-	mVpp	
Output Capacitance <sup>4</sup>	All	$C_O$	470	1000	3300	$\mu\text{F}$	
Dynamic Response	Peak Deviation <sup>5</sup>	$\pm V_O$ $T_s$	-	355	-	mV $\mu\text{S}$	
	Settling Time <sup>6</sup>	$\pm V_O$ $T_s$	-	345	-	mV $\mu\text{S}$	
Turn-on Transient	Rise Time	$V_{IN,DC}=48\text{Vdc}$ , $I_O=I_{O,max}$	$T_{rise}$	-	175	-	mS
	Turn-on Delay Time	$I_O=50\%I_{O,max}$	$T_{turn-on}$	-	80	-	mS
	Turn-on Overshoot	$I_O=0$		-	-	5	$\%V_{dc}$
Switching Frequency	All	$f_{sw}$	-	340	-	KHz	
Output Voltage Trim Range	All		25	-	57	Vdc	
Output Over Voltage Protection <sup>7</sup>	All		60	-	75	Vdc	
Over Temperature Protection <sup>8</sup>	All	T	105	115	125	$^\circ\text{C}$	
Output Voltage Set-Point	$V_{IN,DC}=V_{IN,nom}$ $I_O=50\%I_{O,max}$ $T_A=25\text{ }^\circ\text{C}$	$V_O$	49.5	50	50.5	Vdc	

Note 1 -  $T_A=25^\circ\text{C}$ , airflow rate=400LFM,  $V_{IN,DC}=48\text{Vdc}$ , nominal output voltage unless otherwise noted.

Note 2 - Hiccup: auto-restart when over current condition is removed.

Note 3 - See figure 2 for more details, test condition: see figure 19.

Note 4 - High frequency and low ESR is recommended.

Note 5 - See figure 4 for more details; test condition: see figure 14.

Note 6 - Recovery to within 1% $V_{O,nom}$ .

Note 7 - Latch.

Note 8 - Auto recovery; over temperature protect test point: see figure 11.

# ELECTRICAL SPECIFICATIONS

## AGQ500-48S50-6L Performance Curves

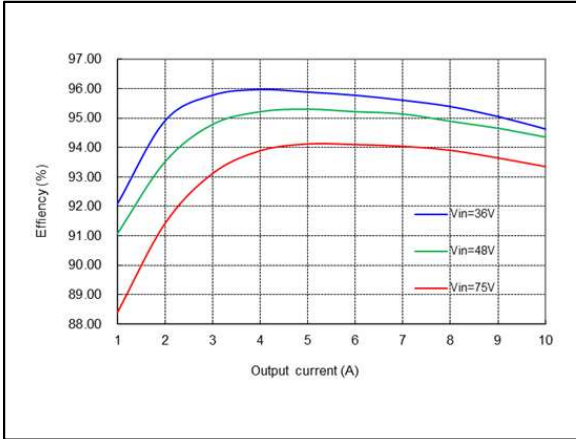

Figure 1: AGQ500-48S50-6L Efficiency Versus Output Current Curve  
 Vin = 36 to 75Vdc Vo=50V Load: Io = 1 to 10A

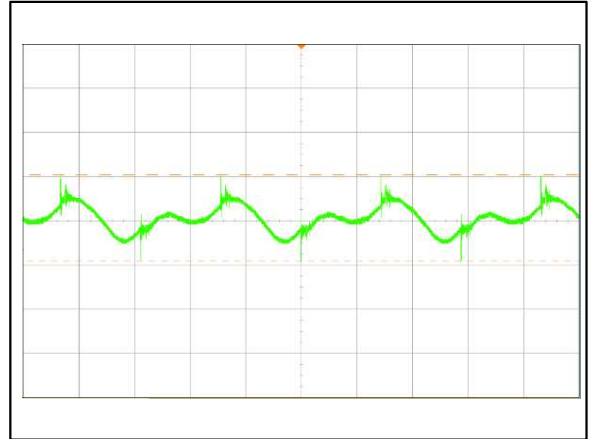

Figure 2: AGQ500-48S50-6L Ripple and Noise Measurement  
 2us/div, 50mV/div

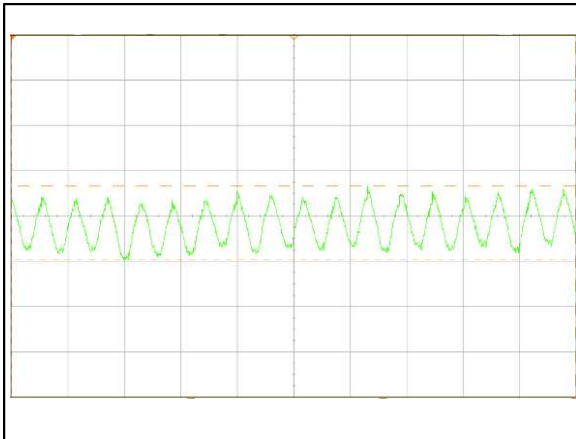

Figure 3: AGQ500-48S50-6L Input reflected ripple current  
 5uS/div, 5mA/div

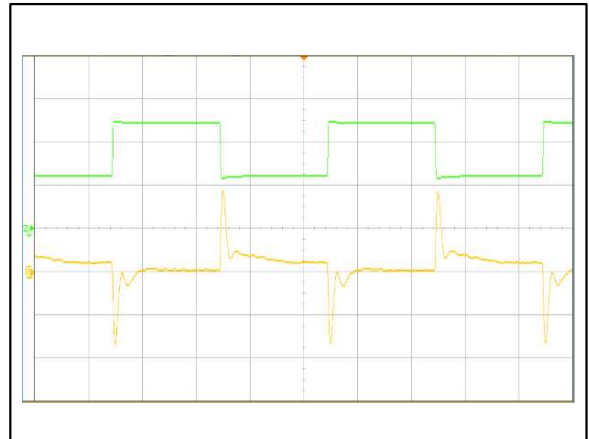

Figure 4: AGQ500-48S50-6L Transient Response(0.1A/uS slew rate, 5mS/div) Load: Io = 25% to 50% to 25% load change  
 Ch 1: Vo-yellow (200mV/div), Ch2: Io-green (2A/div)

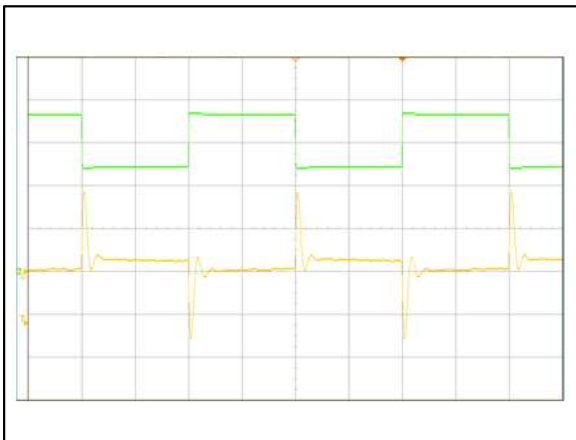

Figure 5: AGQ500-48S50-6L Transient Response(0.1A/uS slew rate, 2mS/div) Load: Io = 50% to 75% to 50% load change  
 Ch 1: Vo-yellow (200mV/div), Ch2: Io-green (2A/div)

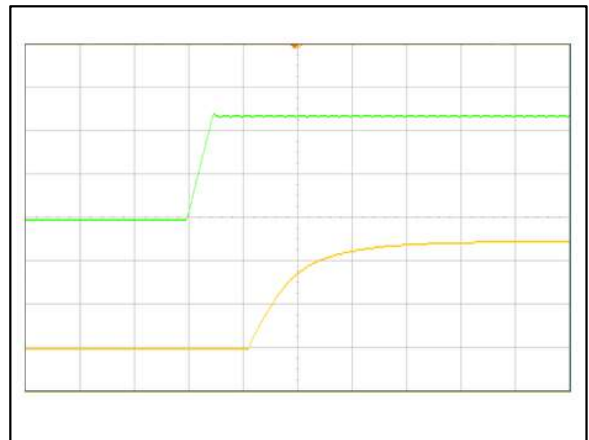

Figure 6: AGQ500-48S50-6L Start up Characteristic by power on (100mS/div)  
 Ch 1: VIN-yellow (20V/div), Ch2: Vo-green (20V/div)

# ELECTRICAL SPECIFICATIONS

## AGQ500-48S50-6L Performance Curves

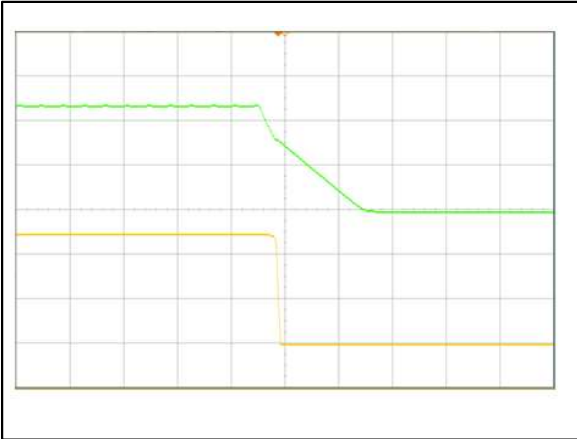

Figure 7: AGQ500-48S50-6L Shut down Characteristic by power off(50mS/div)  
Ch 1: VIN-yellow (20V/div), Ch2: Vo-green (20V/div)

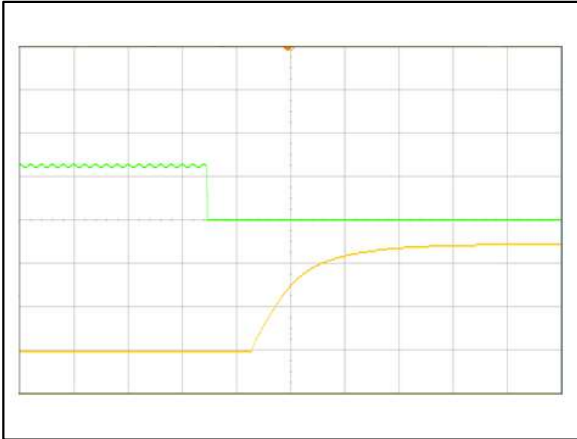

Figure 8: AGQ500-48S50-6L Remote ON Waveform(100mS/div)  
Ch 1: Vo-yellow (20V/div), Ch2: Remote ON-green (5V/div)

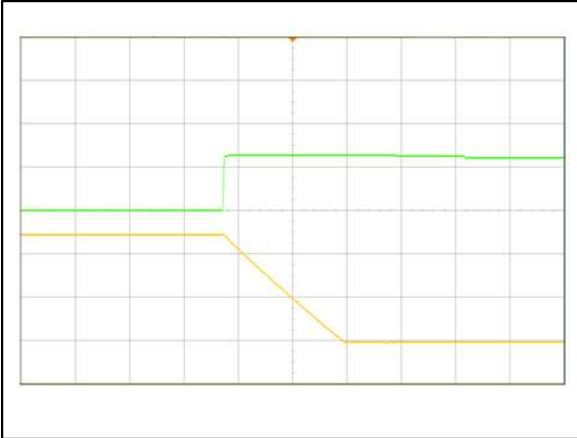
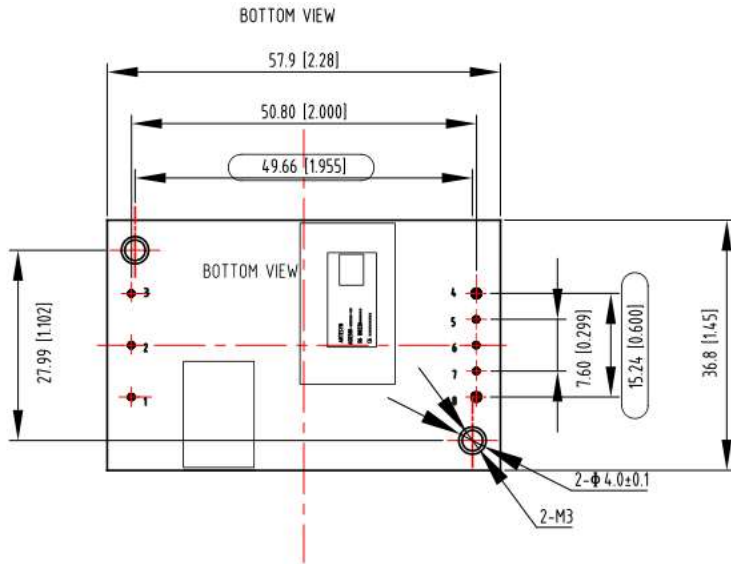

Figure 9: AGQ500-48S50-6L Remote OFF Waveform(2mS/div)  
Ch 1: Vo-yellow (20V/div), Ch2: Remote ON-green (5V/div)

# MECHANICAL SPECIFICATIONS

## Mechanical Outlines – Baseplate Module



### Pin Connections

- Pin 1 - Vin+
- Pin 2 - Remote ON/OFF
- Pin 3 - Vin-
- Pin 4 - Vo-
- Pin 5 - S-
- Pin 6 - Trim
- Pin 7 - S+
- Pin 8 - Vo+

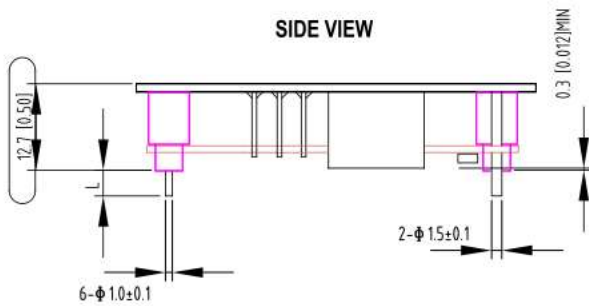

Note:

1. All dimensions is mm (inches)
2. Tolerance: X.X $\pm$ 0.5mm (X.XX $\pm$ 0.02in.)  
X.XX $\pm$ 0.25mm ( X.XXX $\pm$ 0.01in.)
3. Dimensions within the box are critical dimensions
4. Depth penetration into base plate, of M3 screws used at baseplate mounting holes, not to exceed maximum of 3.0mm.

Device code suffix	L
-4	4.6mm $\pm$ 0.5mm
-6	3.8mm $\pm$ 0.5mm
-8	2.8mm $\pm$ 0.5mm
None	5.8mm $\pm$ 0.5mm



## ENVIRONMENTAL SPECIFICATIONS

### EMC Immunity:

AGQ500-48S50-6L power supply is designed to meet the following Electromagnetic Compatibility (EMC) immunity specifications.

Table 4. Environmental Specifications		
Document	Description	Criteria
EN55032 Class B Limits	Conducted EMI Limits, DC input port	/
IEC/EN 61000-4-2, Level 3	Electromagnetic Compatibility (EMC) - Testing and measurement techniques: Electrostatic Discharge (ESD) immunity test	B
IEC/EN 61000-4-4, Level3	Electromagnetic Compatibility (EMC) - Testing and measurement techniques: Electrical Fast Transient (EFT). DC input port	B
IEC/EN 61000-4-5	Electromagnetic Compatibility (EMC) - Testing and measurement techniques: Immunity to Surges (Surges) - 600V common mode and 600V differential mode for DC input port	B
IEC/EN 61000-4-6, Level 2	Electromagnetic Compatibility (EMC) - Testing and measurement techniques: Continuous Conducted Interference. DC input port	A
EN61000-4-29	Electromagnetic Compatibility (EMC) - Testing and measurement techniques: Voltage Dips and Short Interruptions and Voltage Variations (Dips). DC input port	B

Criterion A: Normal performance during and after test.

Criterion B: For EFT and Surges, low-voltage protection or reset is not allowed. Temporary output voltage fluctuation ceases after disturbances ceases, and from which the EUT recovers its normal performance automatically.

For Dips and ESD, output voltage fluctuation or reset is allowed during the test, but recovers to its normal performance automatically after the disturbance ceases.

Criterion C: Temporary loss of output, the correction of which requires operator intervention.

Criterion D: Loss of output which is not recoverable, owing to damage to hardware.

## APPLICATION NOTES

### EMC Test Conditions:

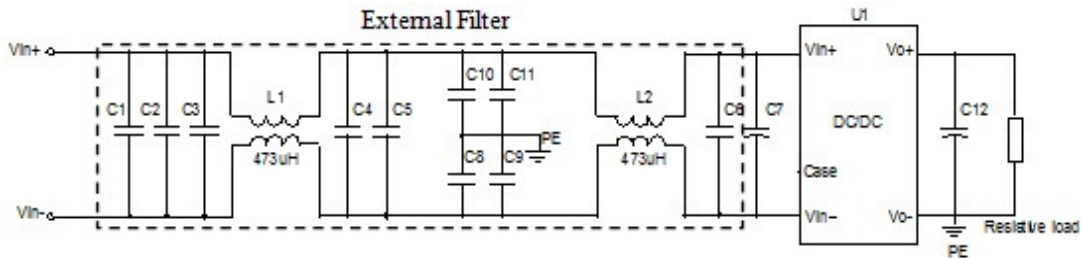

Figure 10 EMC test configuration

U1: Module to test, AGQ500-48S50-6L.

C1 ~ C5: 1 $\mu$ F/100V X7R ceramic capacitor, P/N: C3225X7R2A105K(TDK) or equivalent caps.

C6:0.1 $\mu$ F/100V X7R ceramic capacitor, P/N: 12101C104JAT2A (AVX) or equivalent caps.

C8 ~ C11: 0.47 $\mu$ F/630V ceramic capacitor, P/N: C5750X7T2J474K250KC (TDK) or equivalent caps.

C7: 470 $\mu$ F/100V electrolytic capacitor, P/N: UPM2A471MHD (Nichicon) or equivalent caps.

C12:2\* 470 $\mu$ F/100V electrolytic capacitor, P/N: UPM2A471MHD (Nichicon) or equivalent caps or equivalent PE: Connect to Vo-, Case: Not connected.

## ENVIRONMENTAL SPECIFICATIONS

### Safety Certifications

The AGQ500-48S50-6L power supply is intended for inclusion in other equipment and the installer must ensure that it is in compliance with all the requirements of the end application. This product is only for inclusion by professional installers within other equipment and must not be operated as a stand alone product.

Table 5. Safety Certifications for AGQ500-48S50-6L series module	
Standard	Description
UL/CSA 62368	US and Canada Requirements
EN62368	European Requirements
IEC62368	International Requirements
CE	CE Marking

# ENVIRONMENTAL SPECIFICATIONS

## Thermal Considerations

The converter can operate in an enclosed environment without forced air convection. Cooling of the converter is achieved mainly by conduction from the baseplate to a heatsink. The converter can deliver full output power at 85°C ambient temperature provided the baseplate temperature is kept below the max values in the table 6. Figure 13 shows the derating output current vs. baseplate temperature. The baseplate temperature test points locations are shown in figure 12.

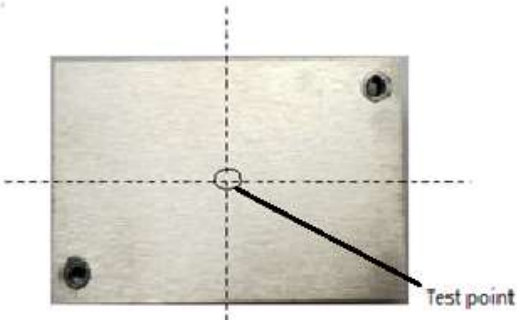

Figure 11 Temperature test point on AL-Baseplate



Figure 12 Temperature test points

Table 6. Temperature Limit of the test points	
Test Point	Temperature limit
Test point	100 °C
Test point-1	105 °C

For a typical application, Figure 12 shows the derating of output current vs. ambient air temperature at different air velocity.

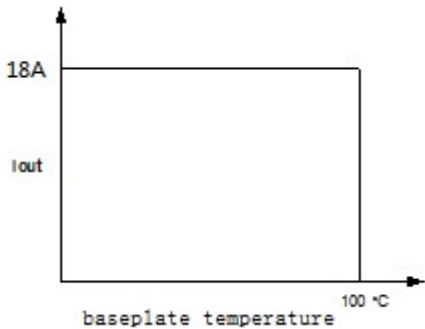

Figure 13 Output power derating, 48V<sub>in</sub>

## ENVIRONMENTAL SPECIFICATIONS

**Table 7. Qualification Certifications**

Parameter	Unit(pcs)	Test Condition
Halt test	4~5	-20 °C to +35 °C, 5 °C step, $V_{IN,DC}=V_{IN,min}$ to $V_{IN,max}$ , $I_O=I_{O,min}$ to $I_{O,max}$
Vibration	3	Frequency range: 5Hz ~ 20Hz, 20Hz ~ 200Hz, A.S.D: 1.0m <sup>2</sup> /s <sup>3</sup> , -3db/oct, Axes of vibration: X/Y/Z Time: 30min/axes
Mechanical Shock	3	30g, 6ms, 3 axes, 6 directions, 3 time/direction
Thermal Shock	3	-55 °C to 125 °C, temperature 20 cycles
Thermal Cycling	3	-40 °C to 85 °C, temperature change rate: 1°C/min, cycles: 2cycles
Humidity	3	40 °C, 95%RH, 48hrs
Solder ability	15	IPC J-STD-002C-2007

## APPLICATION NOTES

### Typical Application

This is the typical application of the AGQ500-48S50-6L power supply, more details refer to Figure 10.

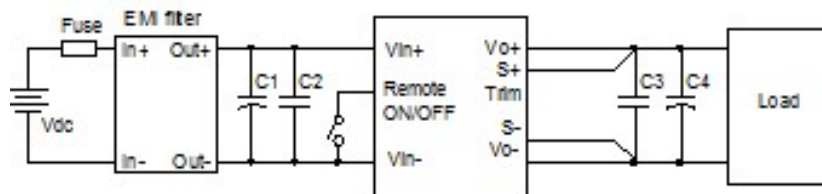

Figure 14 Typical application

C1: 470 $\mu$ F/100V electrolytic capacitor, P/N: UPW2A471MHD(Nichicon) or equivalent

C2: 0.1 $\mu$ F/100V X7R ceramic capacitor, P/N: 12101C104JAT2A (AVX) or equivalent caps

C3: 1 $\mu$ F/100V X7R ceramic capacitor, P/N: C3225X7R2A105KT0L0U (TDK) or equivalent

C4: 2x470 $\mu$ F/100V electrolytic capacitor, P/N: UPM2A471MHD (Nichicon) or equivalent caps

Fuse: 30A fast blow fuse. P/N: 314030P (LITTLEFUSE).

Double minimum input/output capacitance is necessary for normal operation and performance in case of  $T_a < 0^\circ\text{C}$ .

# APPLICATION NOTES

## Remote ON/OFF

Either positive or negative remote ON/OFF logic is available in AGQ500-48S50-6L. The logic is CMOS and TTL compatible. The following figure is the detailed internal circuit and reference in AGQ500-48S50-6L.

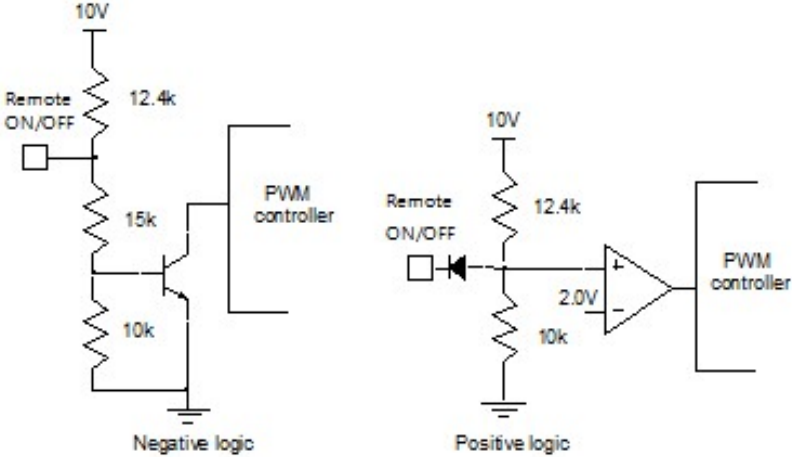

Figure 15 Remote ON/OFF internal diagram

## APPLICATION NOTES

### Trim Characteristics

Connecting an external resistor between Trim pin and Vo- pin will decrease the output voltage, while connecting it between Trim and Vo+ will increase the output voltage. The following equations determine the external resistance to obtain the trimmed output voltage.

$$R_{adj\_down} = \left( \frac{100\%}{\Delta\%} - 2 \right) k\Omega$$

$$R_{adj\_up} = \left( \frac{V_{norm} (100\% + \Delta\%)}{1.225 \times \Delta\%} - \frac{100\% + 2 \times \Delta\%}{\Delta\%} \right) k\Omega$$

$\Delta$  : Output rate against normal output voltage.

$$\Delta = \left| \frac{100 \times (V_o - V_{norm})}{V_{norm}} \right|$$

$V_{norm}$  : Normal output voltage

For example, to get 57V output, the trimming resistor is

$$\Delta = \frac{100 \times (V_o - V_{norm})}{V_{norm}} = \frac{100 \times (57 - 50)}{50} = 14$$

$$R_{adj\_up} = \frac{50 \times (100\% + 14\%)}{1.225 \times 14\%} - \frac{100\% + 2 \times 14\%}{14\%} = 323.2 (K\Omega)$$

For 1% adjustment resistor, the trimmed output voltage is guaranteed within  $\pm 2\%$ .

The output voltage can also be trimmed by potential applied at the Trim pin.

$$V_o = (V_{trim} + 1.225) \times 20.38$$

Where  $V_{trim}$  is the potential applied at the Trim pin, and  $V_o$  is the desired output voltage.

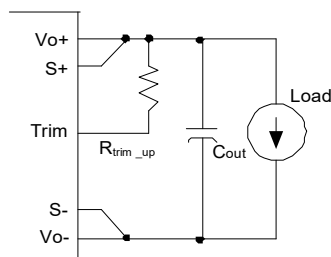

Figure 16 Trim up

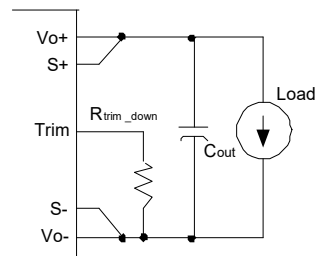

Figure 17 Trim down



## APPLICATION NOTES

For AGQ500-48S50-6L, if the sense compensate function is not necessary, connect S+ to Vo+ and S- to Vo- directly. When trimming up, the output current should be decreased accordingly so as not to exceed the maximum output power. When trimming up the output voltage, the minimum input voltage should be increased as shown in below figure 18.

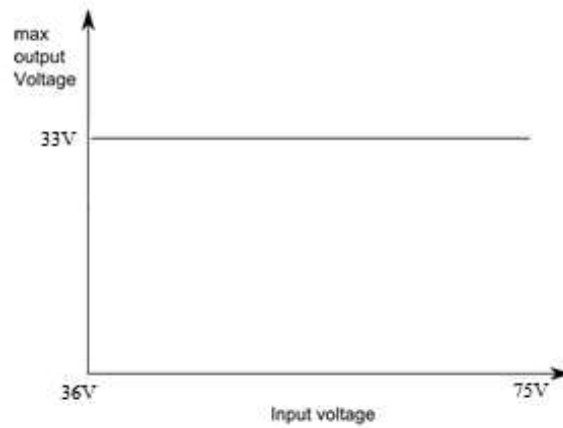

Figure 18 Trimming up the output voltage

## APPLICATION NOTES

### Input Ripple, Output Ripple & Noise Test Configuration

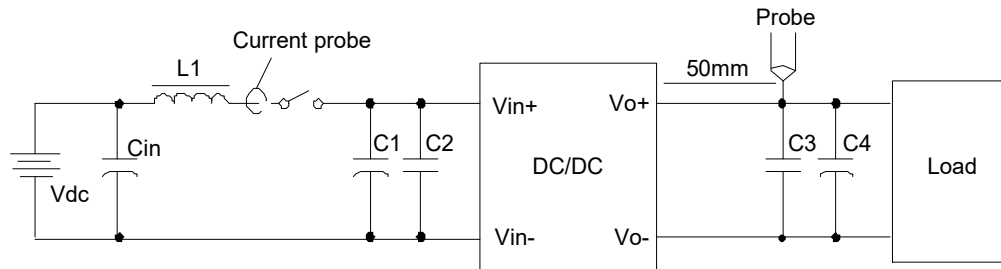

Figure 19 Input ripple, inrush current output ripple & noise test configuration

Vdc: DC power supply

L1: 12 $\mu$ H

Cin: 220 $\mu$ F/100V typical

C1: 470 $\mu$ F/100V electrolytic capacitor, High frequency and low ESR

C2: 0.1 $\mu$ F/100V X7R ceramic capacitor, P/N: 12101C104JAT2A (AVX) or equivalent caps

C3: SMDceramic-100V-1000nF-X7R-1210

C4: 2\* 470 $\mu$ F/100V electrolytic capacitor, High frequency and low ESR

Note: It is recommended to use a coaxial cable with series 50 $\Omega$  resistor and 0.68 $\mu$ F ceramic capacitor or a ground ring of probe to test output ripple & noise.

## SOLDERING INFORMATION

### Soldering

The AGQ500-48S50-6L power supply is intended for standard manual or wave soldering.

When wave soldering is used, the temperature on pins is specified to maximum 260°C for maximum 7s.

When manual soldering is used, the iron temperature should be maintained at 300°C ~ 380°C and applied to the converter pins for less than 10s. Longer exposure can cause internal damage to the converter.

Cleaning of solder joint can be performed with cleaning solvent IPA or simulative.

## RECORD OF REVISION AND CHANGES

Issue	Date	Description	Originators
1.0	02.18.2019	First Issue	K. Ma
1.1	11.19.2019	Update mechanical drawing	K. Ma
1.2	08.16.2024	Remove Radiated EMI Limits	A. Zhang



For international contact information,  
visit [advancedenergy.com](http://advancedenergy.com).

[powersales@aei.com](mailto:powersales@aei.com) (Sales Support)  
[productsupport.ep@aei.com](mailto:productsupport.ep@aei.com) (Technical Support)  
+1 888 412 7832

## ABOUT ADVANCED ENERGY

Advanced Energy (AE) has devoted more than four decades to perfecting power for its global customers. AE designs and manufactures highly engineered, precision power conversion, measurement and control solutions for mission-critical applications and processes.

Our products enable customer innovation in complex applications for a wide range of industries including semiconductor equipment, industrial, manufacturing, telecommunications, data center computing, and medical. With deep applications know-how and responsive service and support across the globe, we build collaborative partnerships to meet rapid technological developments, propel growth for our customers, and innovate the future of power.

**PRECISION | POWER | PERFORMANCE | TRUST**

---

Specifications are subject to change without notice. Not responsible for errors or omissions. ©2020 Advanced Energy Industries, Inc. All rights reserved. Advanced Energy®, and AE® are U.S. trademarks of Advanced Energy Industries, Inc.