

EVERGREEN™ VENTO™ FCM10K

10,000 W Bulk Front End

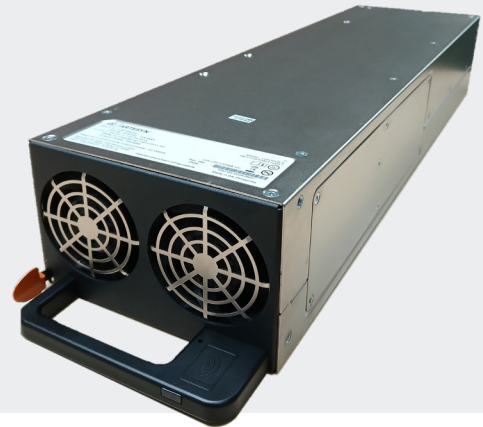

Advanced Energy's FCM10K series provides for three phase three wire of AC-DC embedded power requirements. Featuring high build quality with robust screw terminals, long life, and typical full-load efficiency of greater than 96.3%, reaching a peak of 97%, these units are ideal for use in industrial applications. They are backed by a comprehensive set of industrial safety approvals and certificates. Variable-speed "smart fans" draw on software controls developed by Advanced Energy to match fan speed to the unit's cooling requirement and load current. Slowing the fan not only saves power but also reduces wear, thus extending its life.

SPECIAL FEATURES

- 10,000 W output power
- 81.6 mm x 125.85 mm x 460 mm
- -40 to +50°C
- 5 V at 2 A housekeeping
- Peak efficiency: 97% typical
- Supports NFC Tag Application
- Semi F47 compliance
- Five-year warranty

COMPLIANCE

- EMI Class B, with 6 db margin
- EN61000 Immunity

SAFETY

- UL/IEC/TUV 62368-1
- CE LVD (EN62368-1 + RoHS)
- CB Report Demko for IEC60950-1

AT A GLANCE

Total Power

10,000 W

Input Voltage

187 to 528 VAC, 3 Phase 3 Wire + PE

Number of Outputs

Single



ELECTRICAL SPECIFICATIONS

Input		
Input Range	187 to 528 VAC 3 phase input 480 VAC (nominal)	
Frequency	47 to 63 Hz, nominal 50/60 Hz	
Input Fusing	Internal 20 A non-replaceable fuses per line	
Inrush Current	≤ 60 A peak at 480 VAC	
Power Factor	0.99 typical at nominal input, 50 to 100% of full load, meets EN61000-3-2	
Harmonics	Meets IEC 61000-3-2 requirements	
Input Current	15 A RMS max input current at 480 VAC	
Hold Up Time	12 ms min for at 10,000 W load 20 ms min for at 6000 W load Note: At nominal output voltage	
Efficiency	> 96.3% typical at full load, 480 VAC nominal, 97% typical at half load,	
Leakage Current ³	16 mA (exceed ES2 limit) at 480 VAC, 60 Hz 8 mA (exceed ES2 limit) at 240 VAC, 60 Hz	
Power Line Transient	Suitable MOV after input fuse	
Isolation Voltage	Meets UL62368	
Output		
Output Voltage	Main output: 54.5 VDC Standby output: 5 VDC	
Output Trimming Range	48 to 60 VDC	
Output Current	Main output at 183.5 A max Standby at 2 A	
Minimum Load	Main output at 0 A Standby at 0 A	
Output Ripple/Noise (PARD)	Main output: 1% of voltage setting Standby: 100 mV max	Measured with 0.1 μF ceramic and 10 μF tantalum capacitor on any output, 20 MHz
Output Voltage Turn-on Overshoot	< 5% of voltage setting	Rise is monotonic
Transient Response	± 5% of nominal output voltage	Load transient change of ±25%
Current Sharing Accuracy	< 5% for 50 to 100% load current	Standby: none
Max Number of Unit in Parallel	6 units	
Protections	UV/OV, OCP, OTP, ACUV, etc.	
Output Isolation	Main output is isolated from PSU chassis and meets functional isolation requirements 100 VDC. Design has suitable provision to connect output return to chassis.	

Output Power Derating vs Input Line Voltage	
480 VAC	10,000 W
440 VAC	10,000 W
400 VAC	9200 W
380 VAC	8700 W
360 VAC	8300W
346 VAC	8000 W
240 VAC	5500 W
208 VAC	4800 W

ELECTRICAL SPECIFICATIONS

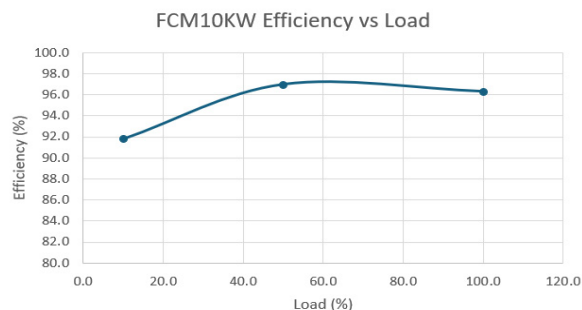
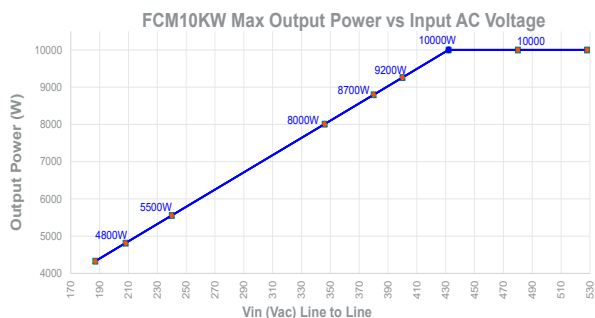

ENVIRONMENTAL SPECIFICATIONS

Operating Temperature	-40 to +50°C; Start at -40°C requires a 5 minute operating warm-up. Above +50 to +70°C, power derating TBA
Storage Temperature	-40 to +85°C
Humidity	10 to 90% non-condensing, operating
Acoustic Noise	< 72 dBA at 30°C
Altitude	3000 m for 100% load 5000 m with derated power (TBD)
Shock	Operating Shock 1: 4 G, 22ms, half-sine pulse Operating Shock 2: 15 G, 11ms, half-sine pulse Non-operating Shock: 30 G, 11ms, half-sine pulse
Vibration	Operating Vibration: IPC-9592B Class 1; Random, 0.71 G rms, 10 to 500Hz Non-operating Vibration: IPC-9592B Class 1, Random, 1.9 Grms, 5 to 500Hz Package: MIL-STD-810G, Method 514.6 Procedure I, Cat 7, Table 514.6C-VII, General Exposure

SAFETY & EMC

Conducted/Radiated Emission	EN55032/CISPR32 Class B, 6 dB Margin
Surge	2 kV DM, 4 kV CM
Voltage Dips and Interruptions	EN61000-4-11 SEMI F47
ESD	8 kV contact/15 kV air
Safety	UL/IEC/TUV 62368-1
Compliance Reports	CE LVD, CB Report Demko for IEC60950-1, TUV SUD, IEC62368, ROHS3

ORDERING INFORMATION

Standard	Nominal Output Voltage	Trim Range	Max Current	Standby Output	Efficiency
FCM10KW-N	54.5 VDC	48 to 60 VDC	183.5 A	5 V at 2 A	96.3%

Note: Add "-T" for Terminal Block

Add "-P" for Pluggable Connector

MECHANICAL DRAWINGS (-P)

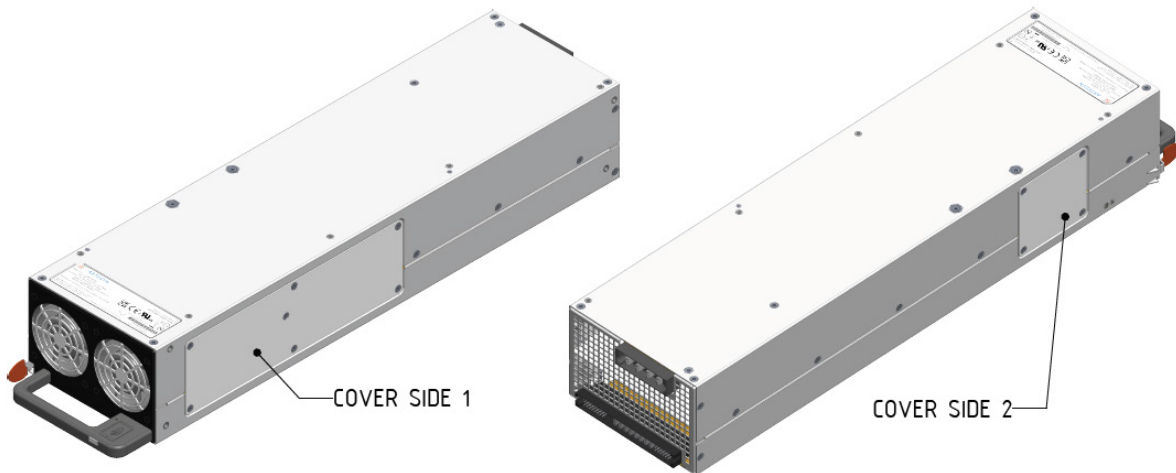
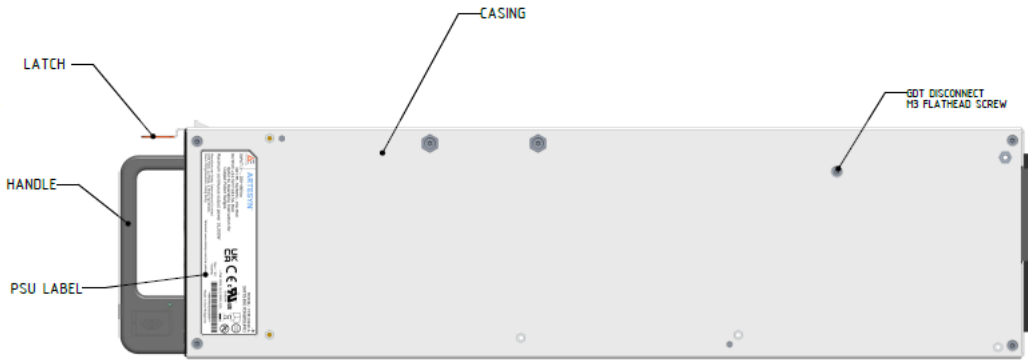

MECHANICAL DRAWINGS (-P)

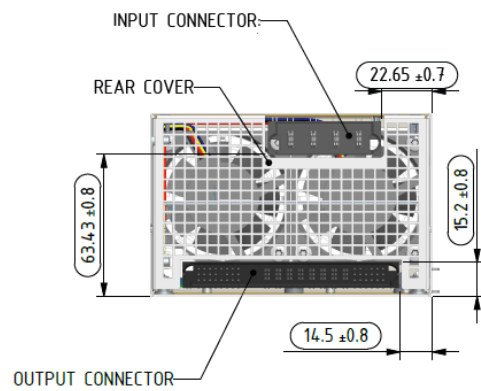
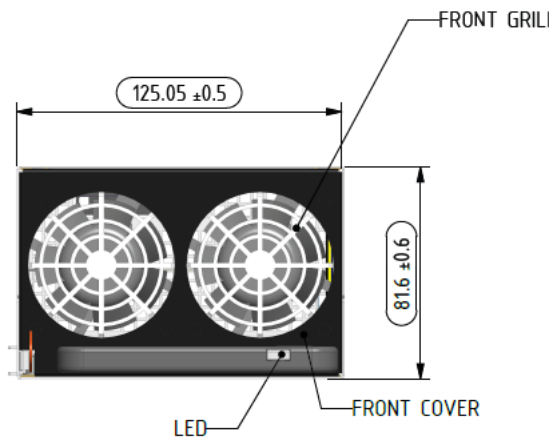
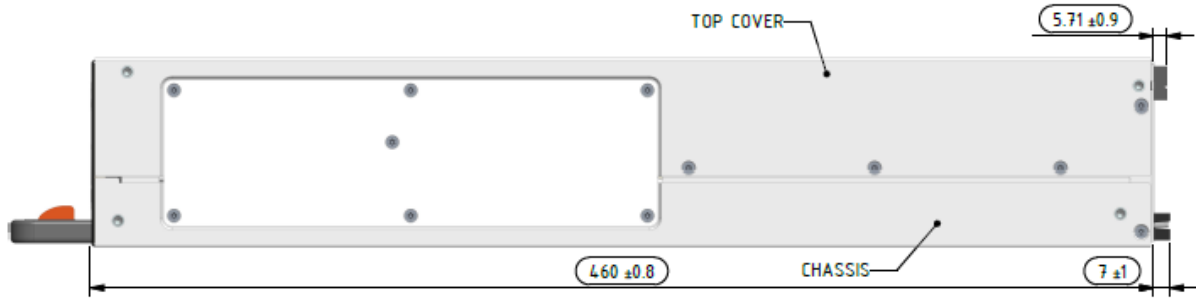

MECHANICAL DRAWINGS (-T)

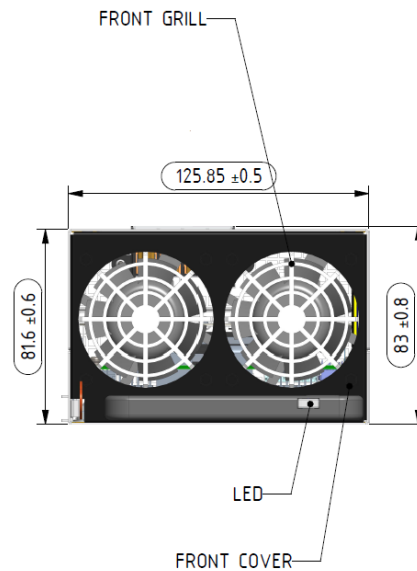
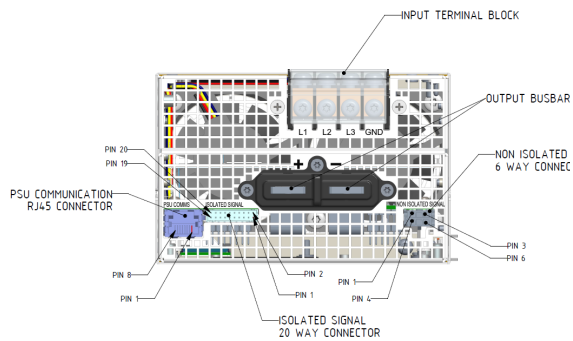
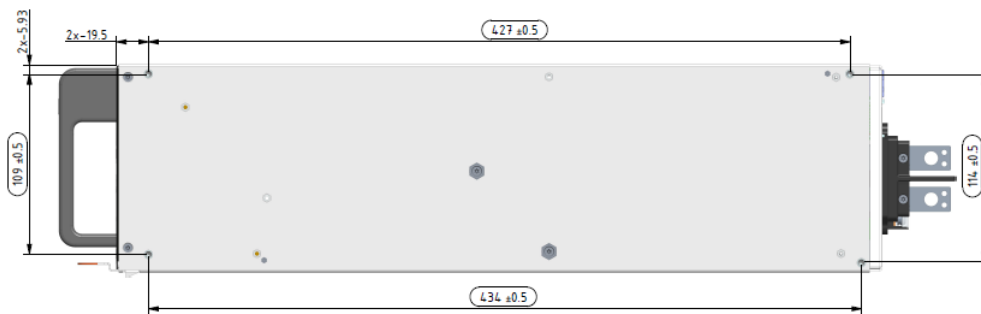
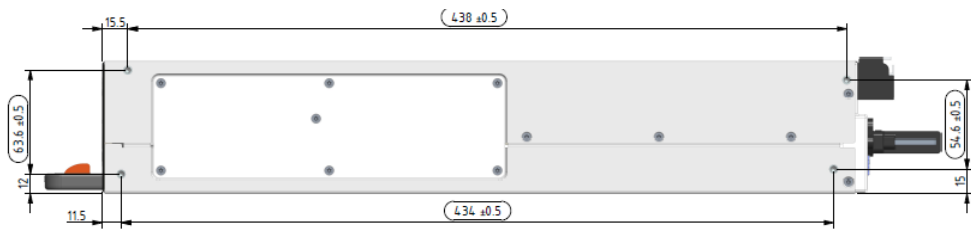
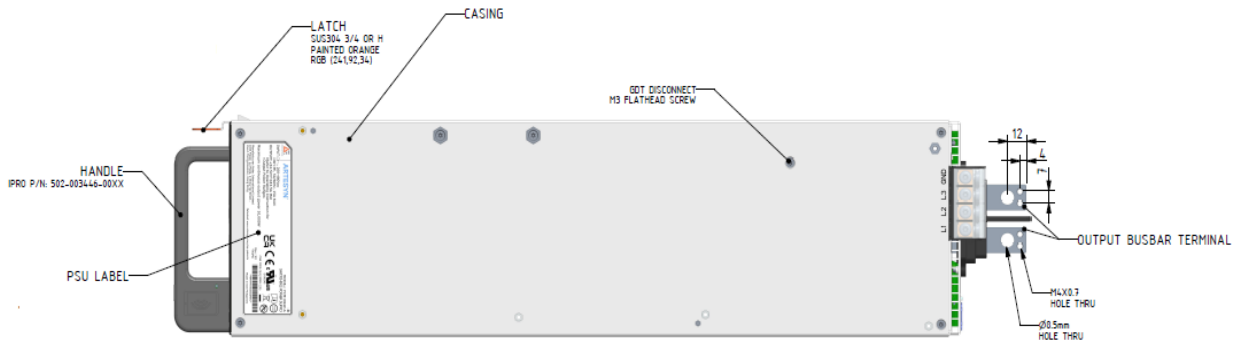

PIN ASSIGNMENT

ISOLATED SIGNALS	PIN # for -P	PIN # for -T
RS485_A_EXT	C5	Pin 11 of J3
RS485_B_EXT	C6	Pin 13 of J3
RS485_GND	B6	Pin 3 of J3
RS485_ADDR0	A7	Pin 5 of J3
RS485_ADDR1	C7	Pin 7 of J3
RS485_ADDR2	C8	Pin 9 of J3
ACOK#	B1	Pin 8 of J3
PWR_OK#	C1	Pin 10 of J3
ALERT#	B4	Pin 20 of J3
PSON#	C3	Pin 12 of J3
V_PROG ¹	B3	Pin 4 of J3
I_PROG	C2	Pin 18 of J3
CC/CV_MODE	C4	Pin 14 of J3
PSU_PRESENT	B8	Pin 15 of J3
GNDL	A8	Pin 6 of J3
5VSB	A1	Pin 2 of J3
5VSB_GND	B2	Pin 1 of J3
PSKILL_ISO	B5	
ANALOG/DIGITAL_MODE	A3	Pin 17 of J3
VPROG/IPROG_GND	A5	Pin 19 of J3
PSU_SYNC_ISO	A2	Pin 16 of J3

NON-ISOLATED SIGNALS	PIN # for -P	PIN # for -T
PSKILL	C11	
ISHARE	C14	Pin 4 of J5
ISHARE_RETURN	C9	Pin 3 of J5
SYS_GND	C10	Pin 1 of J5
PSU_SYNC	C13	Pin 6 of J5
SHLF_DET	B12	Pin 5 of J5

POWER	PIN #
Main Vout+	P2 - P5
Main Vout Return	P6 - P9

Note 1: To enable Vout trimming using external supply voltage, You need to short ANALOG/DIGITAL_MODE pin to GNDL pin. Apply external voltage 0 to 10 V across V_PROG pin and GNDL pin. No need to short ANALOG/DIGITAL_MODE pin to GNDL pin by default Vout trimming is thru RS485

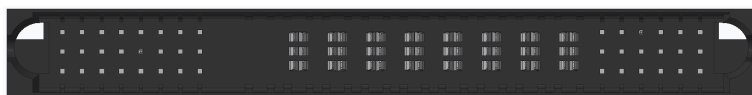

Isolated Signal
+VOUT Main
VOUT Return
Non-isolated Signal

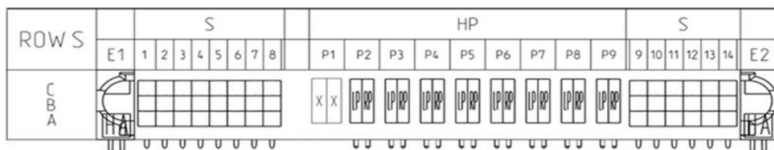

PSU COMMUNICATION
RJ45 CONNECTOR

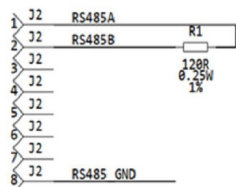

ISOLATED SIGNALS
20 WAY CONNECTOR

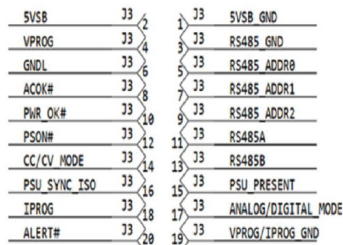

NON ISOLATED SIGNALS
6 WAY CONNECTOR

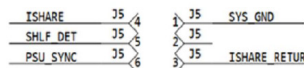

INPUT CONNECTOR



- Three phase AC input using three wire and PE
- Supports star or Delta three phase(no corner grounding)

Kit-1 FCM10K-P Test Kits: 83-788-001

Order Part Number	Description	Diagram
750-018626-0000	Input Mating Connector	
750-018627-0000	6-way Connector (Non-isolated Signal)	
750-018628-0000	20-way Mating Connector (Isolated Signal)	

INPUT CONNECTOR

Kit-2 FCM10K DC Back Plane Test Kits: 83-788-002

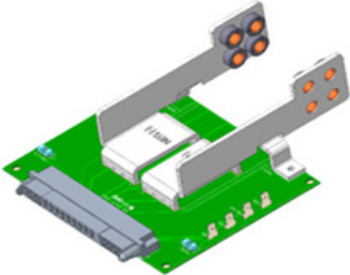
Order Part Number	Description	Diagram
790-026751-0000	Single DCDC Back Plane	

Kit-3 FCM10K-T Test Kits: 83-788-003

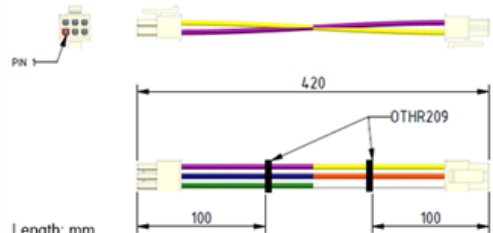
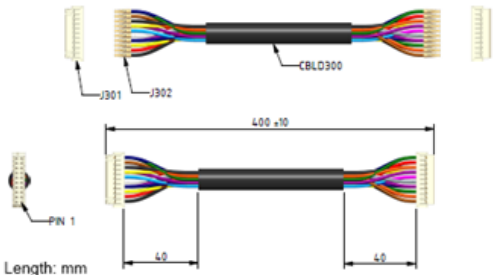
Order Part Number	Description	Diagram
750-018627-0000	6-way Connector (Non-isolated Signal)	
750-018628-0000	20-way Mating Connector (Isolated Signal)	

MISCELLANEOUS SPECIFICATIONS

BURN-IN

100% Burn-in at 45°C, at 80 to 90% load. Duration of burn-in determined by Quality Assurance Procedures.

MTBF

The power supply has a minimum MTBF of 200,000 hours using the Telcordia 2 Method, with specifications at 25°C, ambient, at full load. With the power supply installed in a system in a 35°C ambient environment and operating at full load, capacitor life shall be five (5) years, minimum for ALL electrolytic capacitors contained within this power supply. The power supply shall demonstrate an MTBF level of > 500,000 hours based on actual field population operational hours.

QUALITY ASSURANCE

Full QAV testing shall be conducted in accordance with Advanced Energy standards.

WARRANTY

Advanced Energy shall warrant the power supply to be free of defects in materials and workmanship for a minimum period of five (5) years from the date of shipment, when operated within specifications. The warranty shall be fully transferable to the end owner of the equipment powered by the supply.



For international contact information,
visit [advancedenergy.com](https://www.advancedenergy.com).

powersales@aei.com (Sales Support)
productsupport.ep@aei.com (Technical Support)
+1 888 412 7832

ABOUT ADVANCED ENERGY

Advanced Energy (AE) has devoted more than four decades to perfecting power for its global customers. AE designs and manufactures highly engineered, precision power conversion, measurement and control solutions for mission-critical applications and processes.

Our products enable customer innovation in complex applications for a wide range of industries including semiconductor equipment, industrial, manufacturing, telecommunications, data center computing, and medical. With deep applications know-how and responsive service and support across the globe, we build collaborative partnerships to meet rapid technological developments, propel growth for our customers, and innovate the future of power.

PRECISION | POWER | PERFORMANCE | TRUST

Specifications are subject to change without notice. Not responsible for errors or omissions. ©2025 Advanced Energy Industries, Inc. All rights reserved. Advanced Energy®, AE®, Evergreen™, and Vento™ are U.S. trademarks of Advanced Energy Industries, Inc.